

Learn to weave on the  
**Inklette Loom**



**ashford**  
WHEELS & LOOMS

spinning | weaving | carding | felting | knitting | dyeing

# THE ASHFORD INKLETTE LOOM

Inkle bands are strong and useful braids. Create colourful belts, bracelets, ties, guitar straps, shoe laces or trims for weaving. You can sew them together and make bags, placemats, cushion covers and much more. The Inkle Loom produces a warp-faced band in which the warp completely covers the weft.

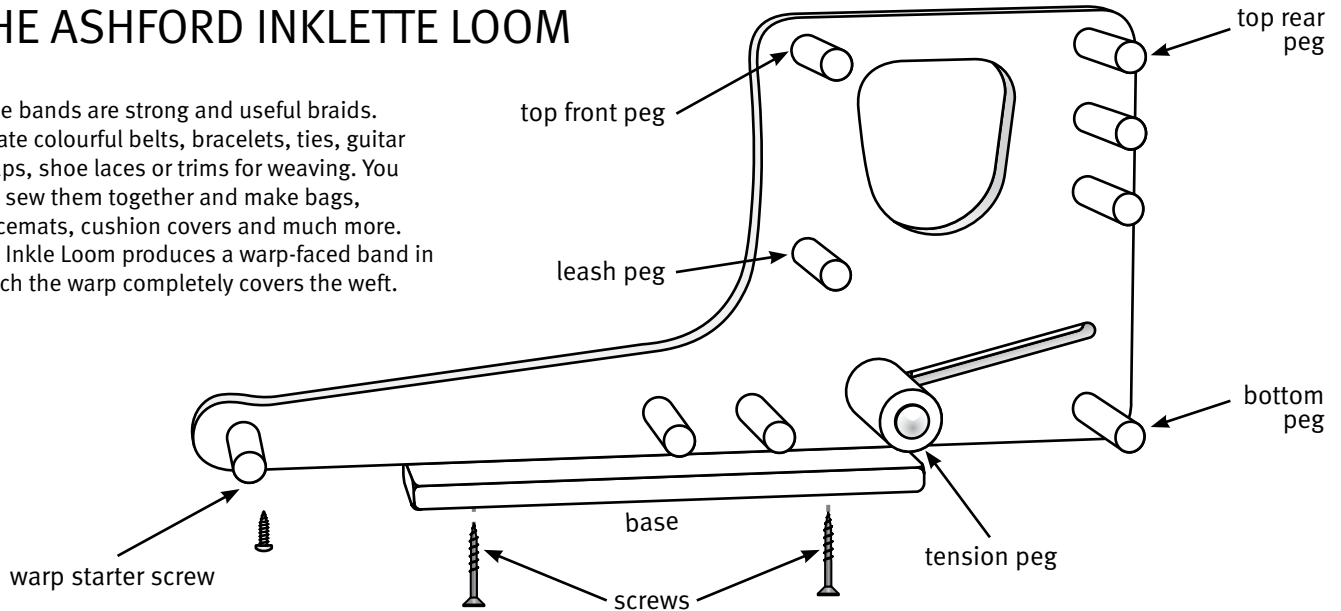

## ASSEMBLE YOUR LOOM

You will need a screw driver, hammer, damp cloth, candle wax or soap (for screw threads), and glue (included).

**Before commencing:** Please read these instructions completely, identify the parts and note the assembly sequence. Use the sandpaper supplied to remove any sharp edges and corners. To make assembly easier, use candle wax on the screws.

**Finishing the wood:** To protect the kiln dried wood from climatic changes and prevent it getting stained or dirty, we recommend the wood surfaces be waxed or sealed. The Beech timber has a lovely variety of colour and grain. For a silky smooth finish, use Ashford Finishing Wax Polish to enhance the natural colours and character of this timber. However please do this after assembly to ensure the glue adheres to the wood.

1. Place the loom flat on a work bench with the holes up. With each peg, check the peg is an easy fit in the hole, if tight use the sandpaper to help it fit nicely. Carefully place a little glue in hole. Too much glue may cause the wood to split! Carefully tap the peg into the hole. Wipe any excess glue away with a damp cloth.
2. Attach the base to the bottom of the loom with 2 long screws.
3. Insert the warp starter round head screw into the bottom of the loom. Leave approx. 1mm ( $1/16$ " ) gap between the wood and head of the screw.

4. Push the bolt through the tension peg, through the slot in the base and secure with the large washer and knob. Tighten the knob to pull the head of the bolt into the wood. Before starting to warp, position the tension peg as illustrated. This will allow the most adjustment as you weave.
5. Please allow at least 4 hours for the glue to harden.

## BEFORE YOU BEGIN:

WARP LENGTH: 1m (39") to 1.8m (70")

WARP WIDTH: up to 50mm (2")

### THE SHED

The shed is obtained by the use of leashes. A thread NOT going through a leash is called an "open" thread.

Shed 1 - is made by pushing down on all the open threads

Shed 2 - is made by lifting all the open threads

### THREADS TO USE

Use strong, smooth and colourful threads. Mercerised cotton is good. Most wool is suitable but avoid wool that is soft or hairy (these tend to cling to each other and make it difficult to obtain a clean, open shed). Textured and metallic threads, silk and nylon add variety. Be experimental but make sure all threads have about the same amount of elasticity, otherwise the surface will be uneven.

### WIDTH OF WARP

Because the weft thread is pulled tight, the weaving will be reduced to about half the original width of the warp. However, if you want to increase or decrease the width at any stage, this is done by the amount of tension on the weft thread.

### SHUTTLE

A shuttle with a bevelled edge for beating is included in the kit.

### TENSION PEG

The tension peg is used to keep the warp under tension when weaving. When moving the weaving around the loom, loosen the tension peg to release the tension. Use two hands to advance the warp. When using a full length warp take care to move the weaving little by little. Do not pull too tight! You could break the pegs!

### LEASHES

Leashes or string heddles are loops that make it possible to create an up and down shed.

# THE LOOM

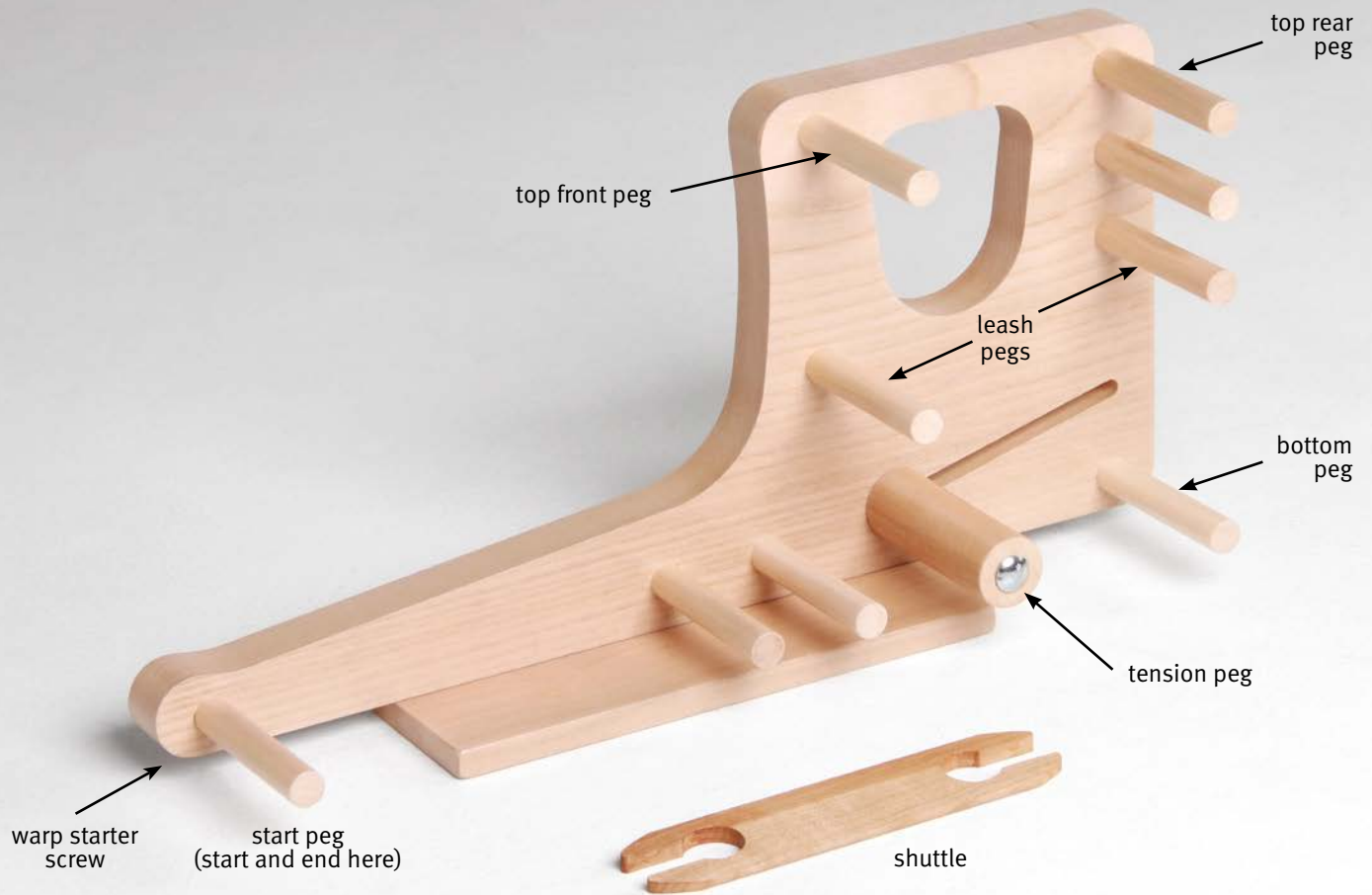

## WARP LENGTHS

Determine how long you want your weaving to be. You can weave between 1 - 1.8 metre-long (50 - 70") warps. Use a piece of scrap yarn to work out the path of the warp.

All warps, from short to long, go from the start peg, over the top front peg and top rear peg then around pegs necessary for the warp length you are making, ensuring you go around the tension peg and around the bottom peg before returning to the start peg again for round 2.

Repeat Round 1 and Round 2 continuously until finished.

**Tension peg:** Before you begin warping set the tension peg approx. 10mm (3/8") from the front of the slot - this will allow you to tighten your warp fully before you begin weaving.

## SHORT WARP

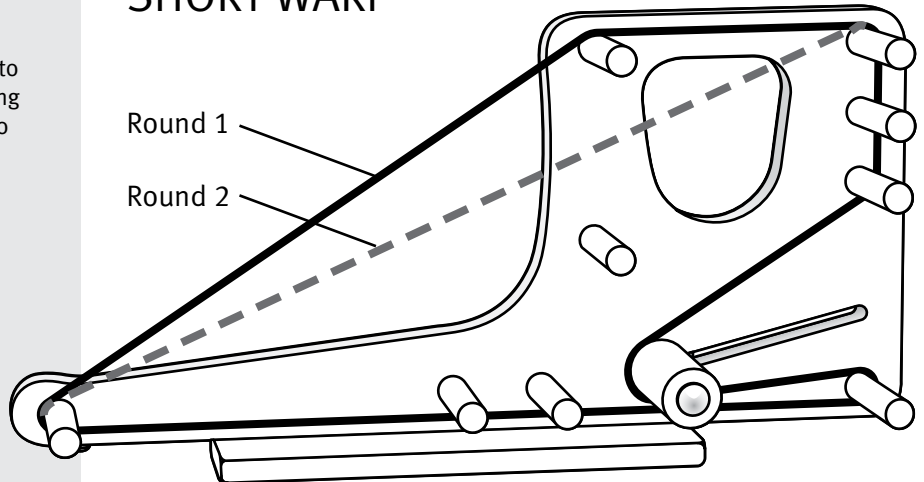

## LONG WARP

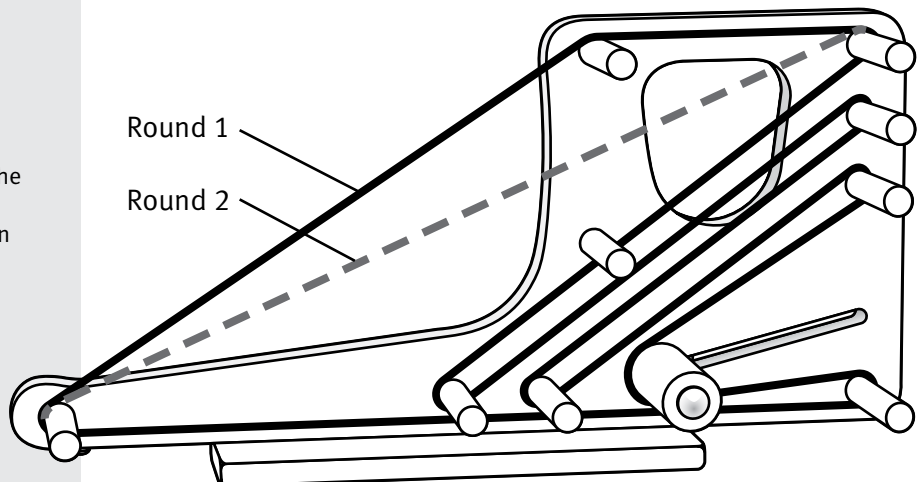

# WARPING THE LOOM

To make your shed for weaving you need to wind the warp alternating Round 1 and Round 2.

ROUND 1: Wrap the beginning of the warp yarn around the starter screw. Take the yarn up and over the top front peg, over the top rear peg and follow the warping pegs (length to suit) including the tension peg and the bottom peg before returning to the starter peg.

ROUND 2: Take the yarn straight up to the top rear peg (under the top front peg) and around the same warping pegs (including the tension peg) and back to the starter peg. Repeat as per your draft.

When changing colours tie the new colour thread to the end of the previous colour thread using a reef knot at the the starter peg.

## HOW TO READ THE DRAFT

Drafts (charts) show the order of warp yarns on the loom. The top line represent threads with a leash and the bottom line represent threads with no leash. Leash (Round 1), no leash (Round 2). Use the draft to warp up your inkle loom. A draft is usually not drawn for the entire width of the woven piece, but only enough to show the pattern for winding the warps. The pattern is then repeated.

## YOUR FIRST PROJECT

### Draft

Round 1.

Round 2.

- 
- |                      |                      |                      |                          |
|----------------------|----------------------|----------------------|--------------------------|
| 1. Round 1 - Black   | 13. Round 1 - Yellow | 25. Round 1 - Green  | 37. Round 1 - Purple     |
| 2. Round 2 - Black   | 14. Round 2 - Yellow | 26. Round 2 - Yellow | 38. Round 2 - Purple     |
| 3. Round 1 - Black   | 15. Round 1 - Green  | 27. Round 1 - Green  | 39. Round 1 - Purple     |
| 4. Round 2 - Black   | 16. Round 2 - Yellow | 28. Round 2 - Green  | 40. Round 2 - Black      |
| 5. Round 1 - Black   | 17. Round 1 - Green  | 29. Round 1 - Green  | 41. Round 1 - Black      |
| 6. Round 2 - Black   | 18. Round 2 - Yellow | 30. Round 2 - Green  | 42. Round 2 - Green      |
| 7. Round 1 - Purple  | 19. Round 1 - Green  | 31. Round 1 - Green  | 43. Round 1 - Green      |
| 8. Round 2 - Purple  | 20. Round 2 - Yellow | 32. Round 2 - Green  | 44. Round 2 - Green      |
| 9. Round 1 - Yellow  | 21. Round 1 - Green  | 33. Round 1 - Black  | 45. Round 1 - Green      |
| 10. Round 2 - Yellow | 22. Round 2 - Yellow | 34. Round 2 - Black  | 46. Round 2 - Green      |
| 11. Round 1 - Yellow | 23. Round 1 - Green  | 35. Round 1 - Purple | 47. Round 1 - Green      |
| 12. Round 2 - Yellow | 24. Round 2 - Yellow | 36. Round 2 - Purple | 48. Round 2 - Yellow.... |



01

Wrap the beginning warp thread around the starter screw. Before starting your warp, set the tension peg 10mm from the front of the slot. This will allow you to tighten your warp if needed once it is fully warped.



02

Round 1. Take the yarn up and over the top front peg and top rear peg. Follow the warping pegs, including the tension peg and bottom peg and return to the starter peg.

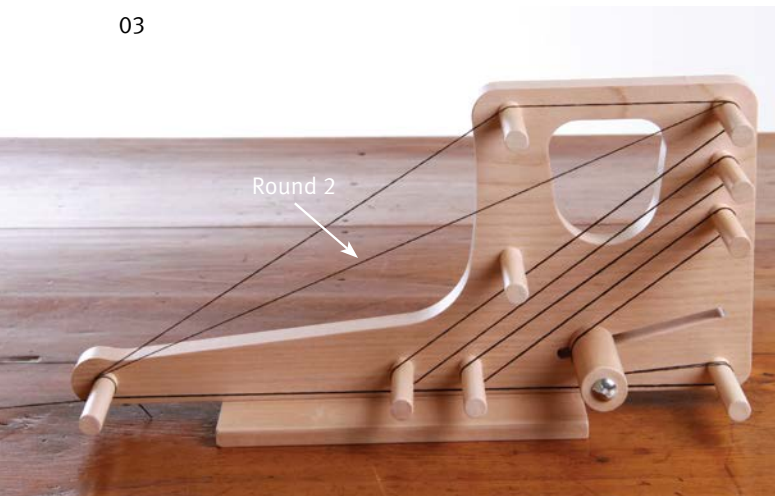

03

Round 2. Take the yarn straight up and over the top rear peg and around the same warping pegs and back to the starter peg. Repeat as per your draft.

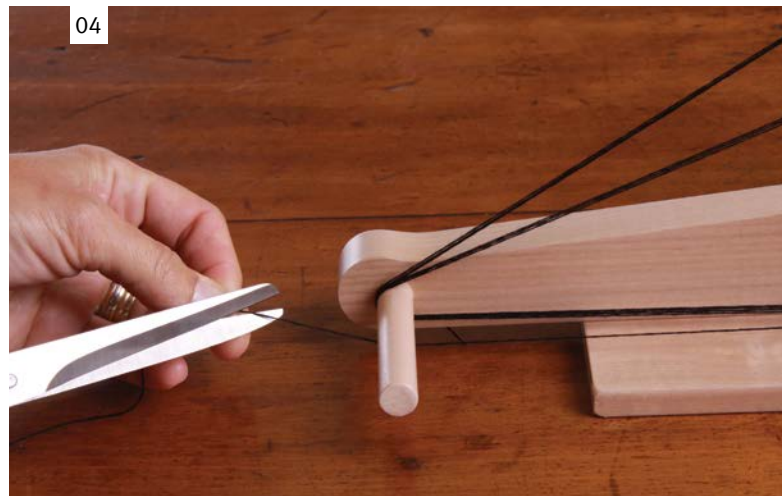

04

When you need to change colours, cut the first colour just past the start peg.

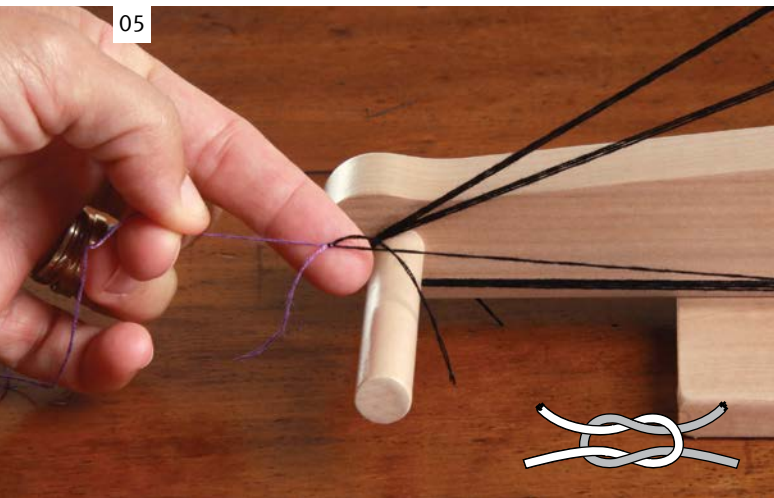

05 Tie on the next colour using a reef knot as shown above.  
(Reef knot: left over right, right over left).

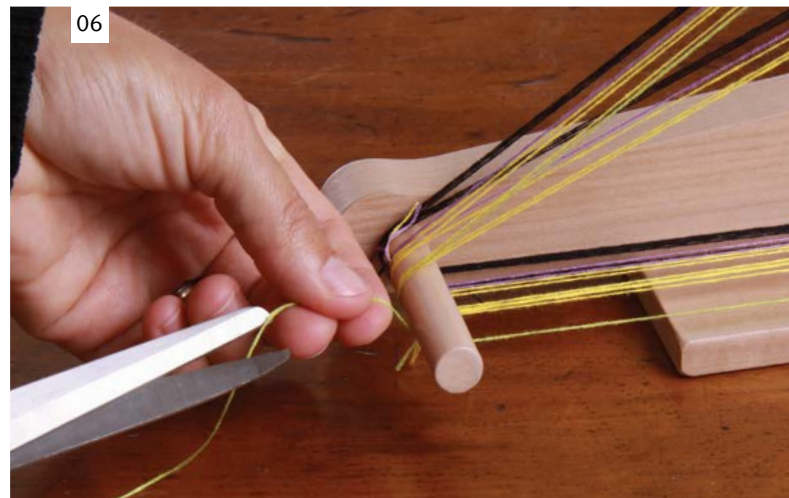

06 Every time you change colours throughout the warp, tie on the new colour at the start peg.

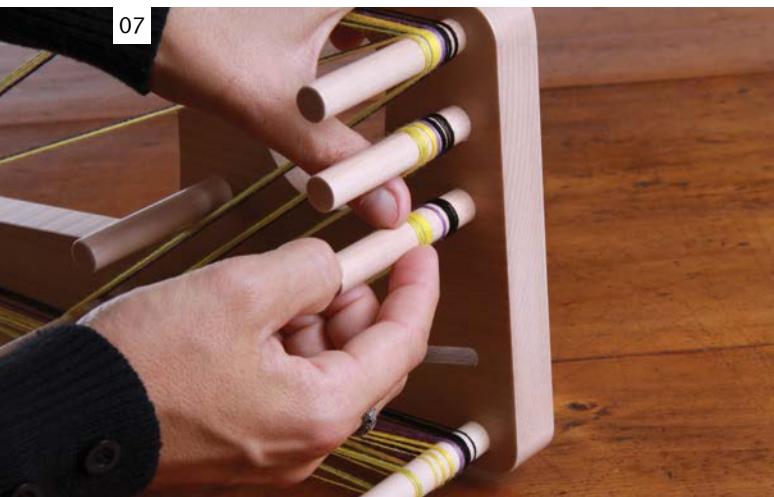

07 As the warp gets wider slide the threads towards the loom side so they do not slip off the pegs.

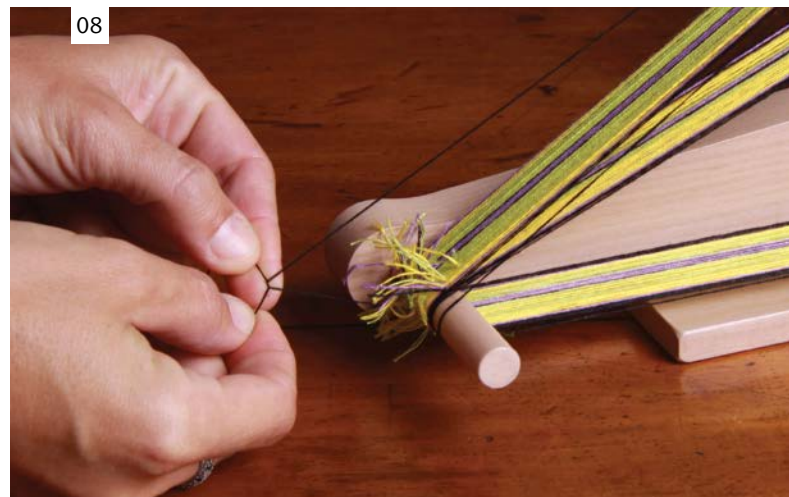

08 When you have completed the warp, tie the last thread to the beginning thread you had wrapped around the starter screw.





Finished warp. Loosen the knob on the tension peg and pull forward to tighten the warp. Now you need to make the leashes.



Making leashes. Use string or fine strong cotton. Wind the string around the two leash pegs as shown until you have enough leashes for your top (Round 1) threads.



Cut the string as shown. Be careful not to cut your warp threads.

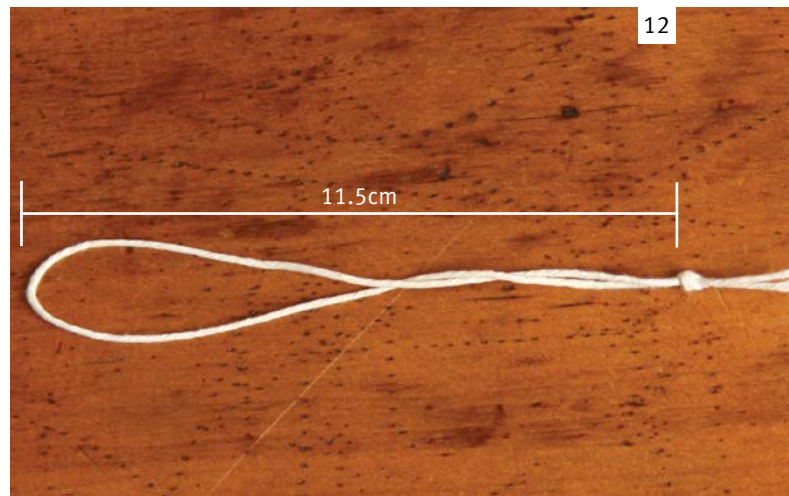

Fold each leash in half and tie a knot 1cm (3/8") from the end. Each leash should be the same length 11.5cm (4 1/2").

13



Adding the leashes. Take a leash up and over the first thread of the warp (Round 1 thread).

14

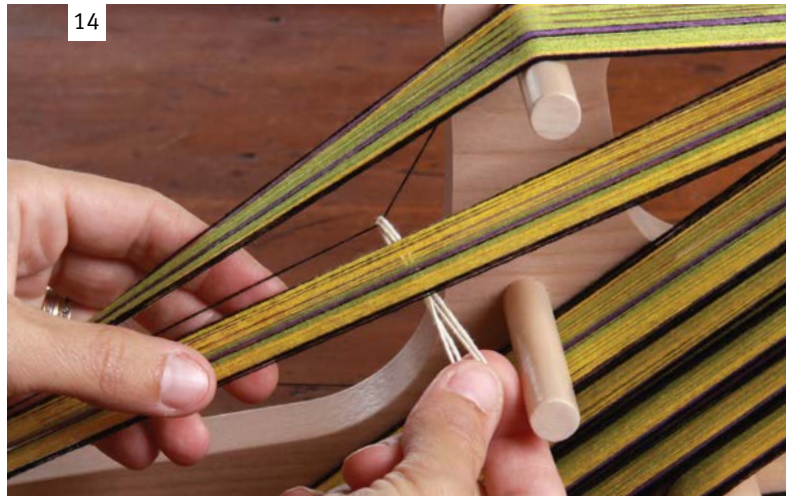

Slip the loops onto the leash peg. NOTE: leashes are only on top threads (Round 1 threads).

15

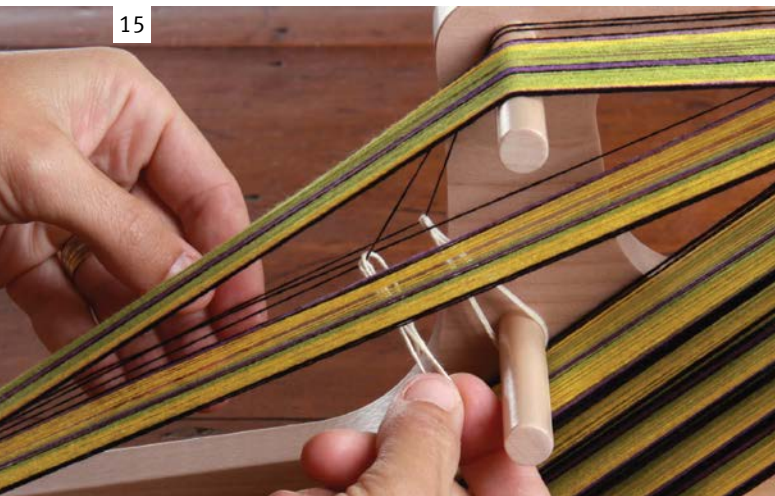

Continue across the warp adding leashes to all Round 1 threads. **Keeping your threads in order**, you should have Round 1 with a leash, then the Round 2 thread, then the next Round 1 with a leash and so on.

16



Shed 1: Push the threads **down** to create a space (shed) in front of the leashes.



17

Shed 2: Push the threads up to create a space (shed) in front of the leashes.



18

Wind the weft thread onto the shuttle. For tidy edges use a weft thread the same colour as the edge warp threads.



19

Spread the warp by making Shed 1 and place in a piece of cardboard. Make Shed 2 and place another piece of cardboard in and gently push into place.

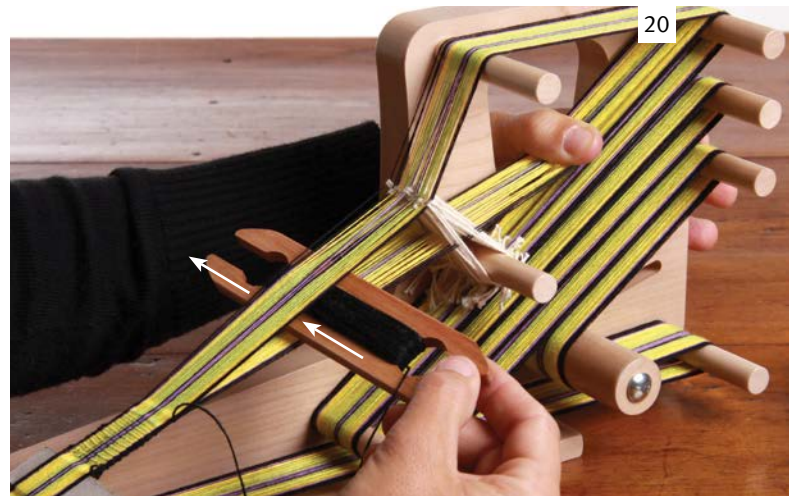

20

You are now ready to weave.  
 Make Shed 1 - **Down**. Pass the shuttle all the way through the space between the threads (threads down, Shed 1).  
 Note: Leave about 10cm of weft thread hanging out, this will be darned in when you have finished.

21

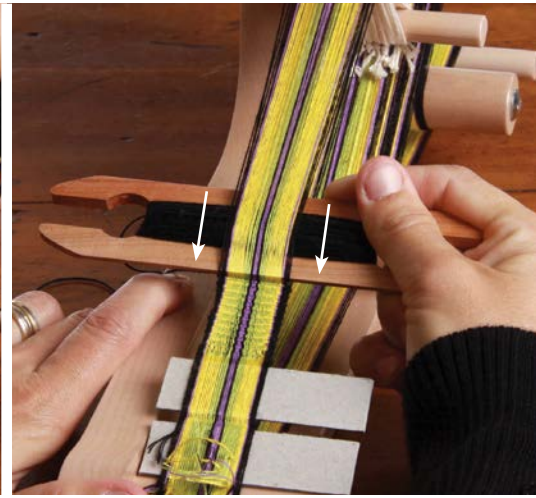
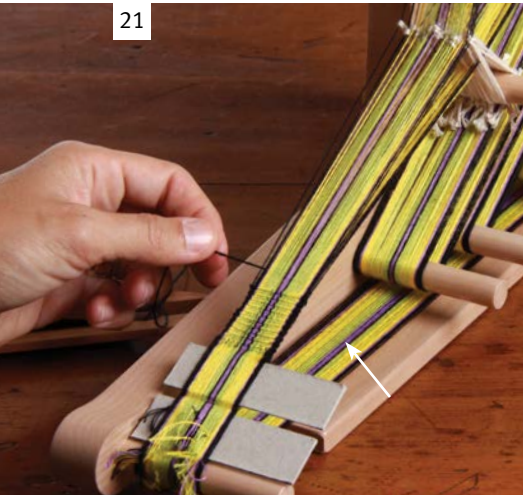

Pull the thread firmly.

Make Shed 2 - **Up**. Put your shuttle into Shed 2 and beat the previous weft firmly into place. Continue taking the shuttle through Shed 2 (after beating).

22

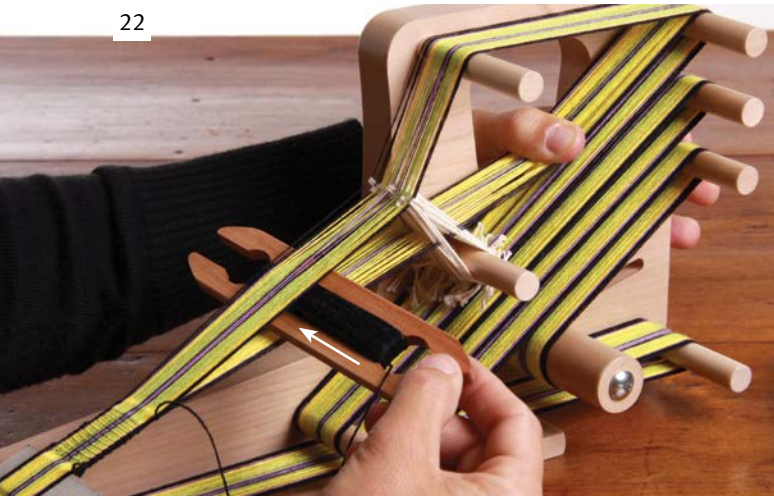

Pull the thread firmly. The warp threads will move together so you cannot see the weft at all through the warp. Change to Shed 1- **Down**. Put your shuttle into Shed 1.

23



Beat the previous weft firmly into place. Continue taking the shuttle through Shed 1. Pull the weft thread tightly. Change back to Shed 2 - **Up**. Repeat this sequence.



Continue weaving.



Winding on. Loosen the nylon knob. Move the tension peg back to loosen the warp.



Pull the warp forward towards you until the end of the woven piece is about 2.5cm (1") from the front peg. All the threads will move around the pegs.



Pull the tension peg forward until the warp is tight. Tighten the nylon knob. As you move the weaving past the start peg you can remove the cardboard spacers. Continue weaving.

28



Stop weaving when you can't weave any longer because the knots in the warp are close to the leashes. You are now ready to remove your weaving from the loom BUT before you do sew in the weft ends.

30

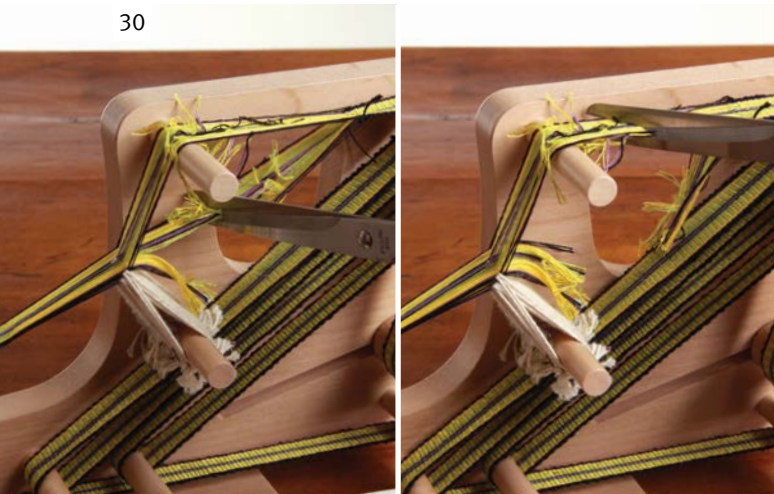

Remove the weaving from the loom by cutting each half of the warp a few centimetres (inches) behind the leashes. Pull the threads out off the leashes. To finish, either let the ends hang loose as a fringe, plait them, twist them, tie knots in them or glue them and cut them close to the braid.

29

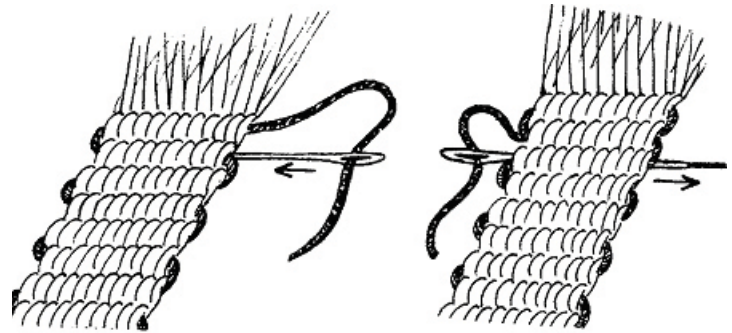

Sewing in weft ends. Sew the weft back three or four sheds to lock it, this is easier to do with the warp under tension.

Hints:

To keep the edges straight when weaving follow these simple rules:

1. Keep the warp very tight. A high tension makes the whole braid and edges look better when finished.
2. Try to keep the same tension.
3. Every time you pull the shuttle out of the shed, before you push the weft into place with the shuttle, pull the previous weft thread again. That will even out the little loops that occur between the two outer warp threads. This is essential for even edges.

# PATTERNS

Apart from the patterns in the warp, there are lots of pick-up and pick-down patterns, patterns using different colours and thicknesses of warp and weft and so on. You can even weave letters and words.

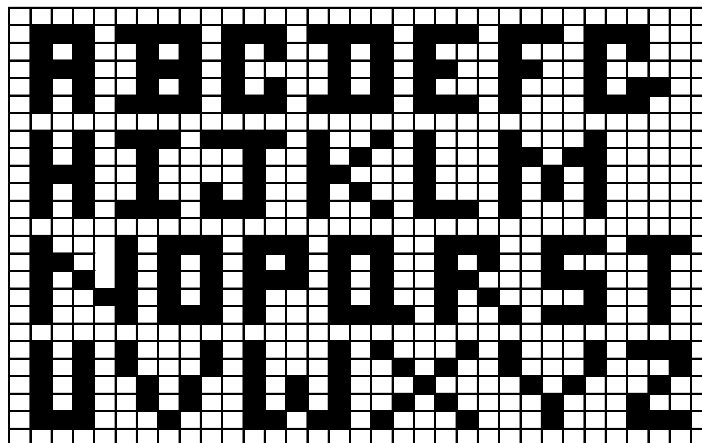

Annie Machale from Soquel, USA sent us this letter chart illustrating how each letter is made up of blocks. NB: In this draft each block consists of 3 consecutive turquoise threads (see draft below). When not needed as part of the letter, you must drop the turquoise out of the way and lift the black from below. For this to work out, you must consider the black and turquoise threads next to each other as complementary pairs. Whenever you drop a turquoise thread, you must pick up its corresponding black thread (the one just to its right) from the lower shed.

For example, the letter A is formed in 3 sheds by the following method:

Row 1: Start the letter by weaving a plain row in the shed with turquoise on top. Pass weft. Change sheds. Beat.

Row 2: All black will be on top. Using your fingers or a pickup stick from left to right, keep the border threads. Next you will pick a turquoise and drop a black. Repeat two more times so that you now have 3 turquoise. Keep the next 3 black. Pick turquoise and drop black for the next three. Keep the next six black. Keep the border threads. Hold all of these up as you pass the weft. Change sheds. Beat.

Row 3: All turquoise will be on top. Pass the weft. Change sheds. Beat.

Note: In the letter chart, each letter stands 5 blocks tall as you read it. Most letters are 3 blocks (shed rows) wide, although letters with diagonal lines will take 4-5 blocks (sheds) to complete.

## Draft

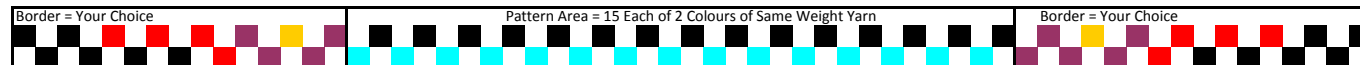

For more information, helpful hints and inspiration visit [www.ashford.co.nz](http://www.ashford.co.nz)



LTWILKVVW1

Ashford Handicrafts Limited

415 West Street, PO Box 474, Ashburton, New Zealand

Ph +64 3 308 9087 sales@ashford.co.nz www.ashford.co.nz

**ashford**  
WHEELS & LOOMS