

Learn to weave on the Sample*It* Loom



ashford
WHEELS & LOOMS

spinning | weaving | carding | felting | knitting | dyeing

The Ashford SampleIt Loom assembly instructions

Before Commencing - Please read the instructions completely, identify the parts and note the assembly sequence. Use the sandpaper supplied to remove any sharp edges and corners.

Finishing the Wood - We recommend that the wood surfaces be waxed or sealed before assembly. This protects the kiln-dried wood from climatic changes and prevents it getting dirty or stained. The timber has a lovely variety of colour and grain. For a silky smooth matt finish, use the Ashford Wax Polish to enhance the natural colours and character of this timber.

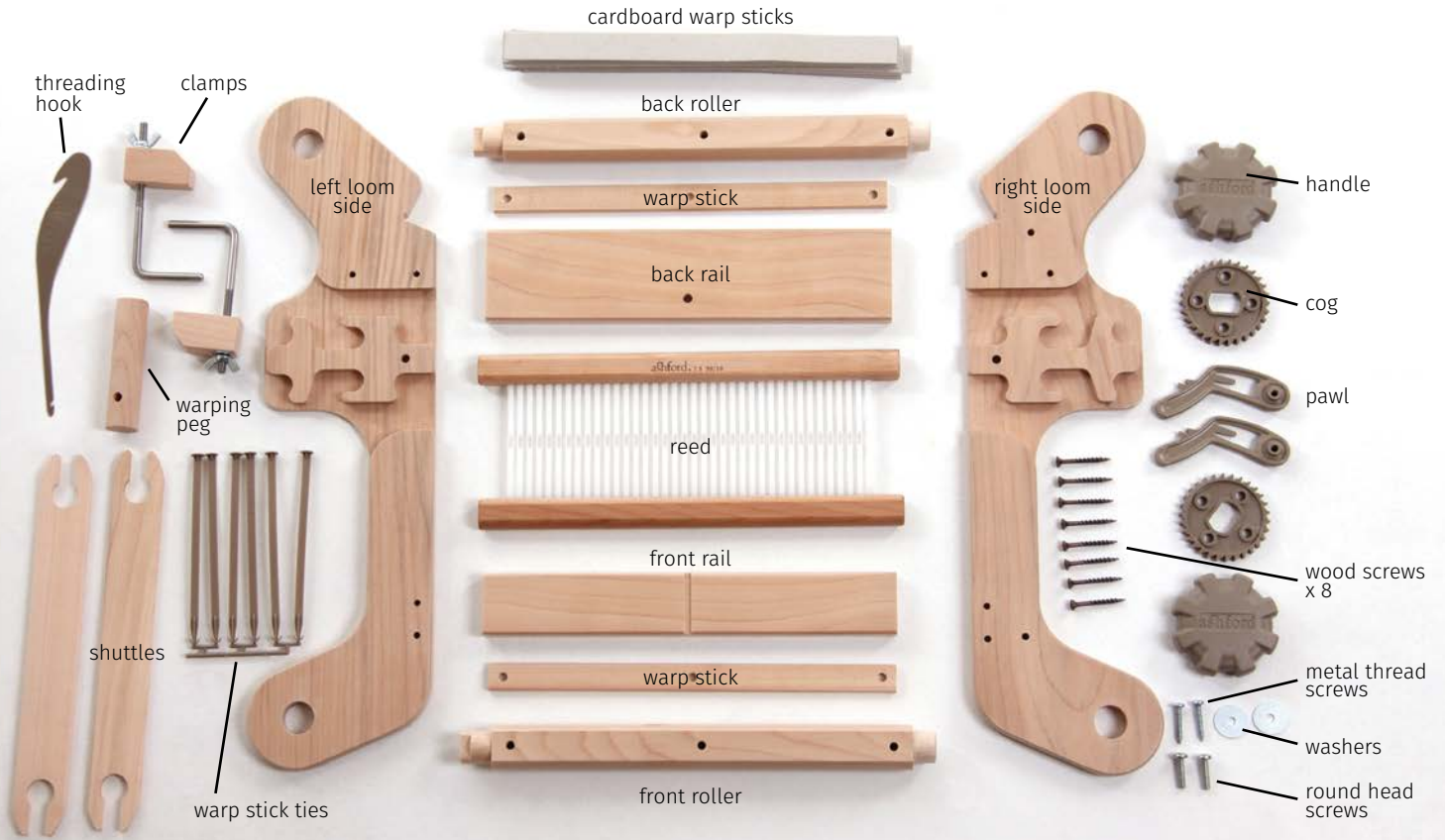
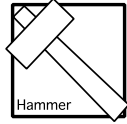
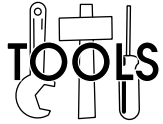



01



02

On the right loom side (with the brand) remove the protective wooden packer from the metal clicker pins, put the pawl in place, turn the loom side over and attach both pawls with a 20mm (3/4in) round head screw. NOTE the "clicker pin" fits into the gap of the pawl. Rub a little candle wax on the thread to make assembly easier. DO NOT over tighten. The pawls should move freely. Leave 0.5mm (1/32in) gap under the head of the screws.



03

Secure the back rail to the right side with two wood screws.

Note: The clamp hole is towards the bottom.



04

Secure the front rail to the right side with two wood screws.

Note: Ensure the groove on the front rail is facing up.



05

Wax both ends of the rollers then place both rollers into the assembled loom side. Check the longer roller end is through the right side of the loom.



06

Locate both rollers into the left side and secure the front and back rails with wood screws.



07

Place the cogs onto the ends of the rollers. Check the teeth engage the pawls.



08

THEN secure with washers and 20mm (3/4in) screws.



09
 Locate the 4 pins on the handles into the 4 holes in the cogs. Then give the handle a sharp hit with the palm of your hand or a rubber hammer so they snap down tight onto the cogs.

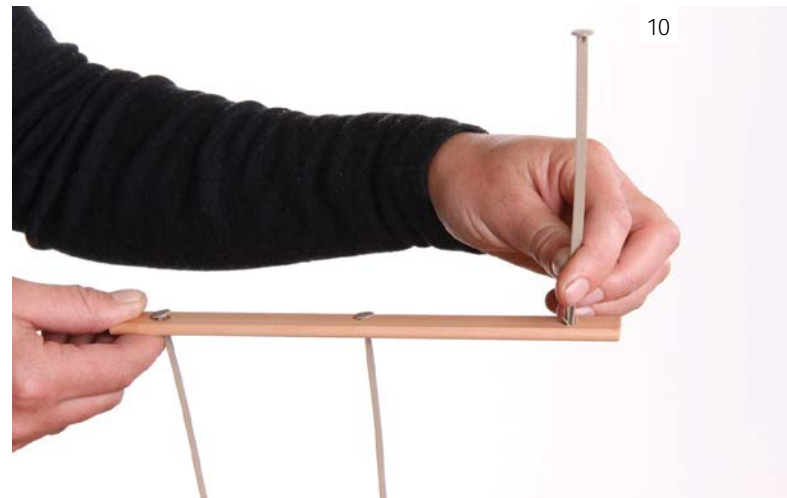

10
 Connect the front and back warp sticks to the rollers with the warp stick ties. Push the arrowhead of the nylon ties through the holes in the warp sticks.



11
 Then push the arrowhead ends into the small hole in the roller and out the larger hole as illustrated.

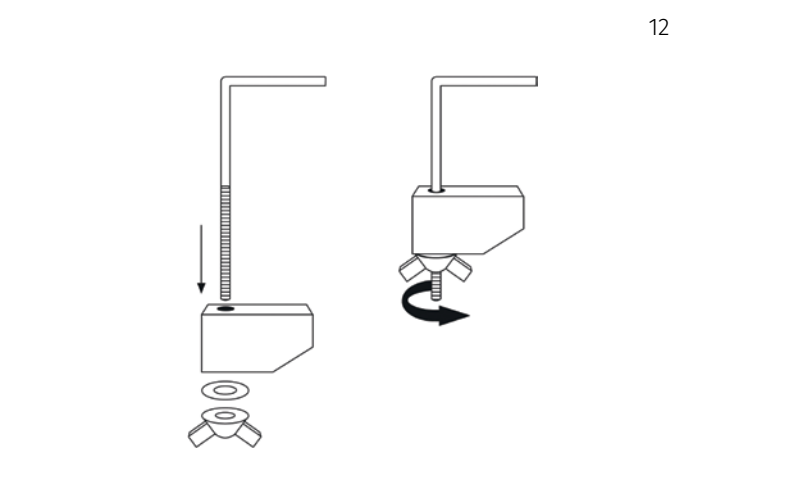

12
 Assemble the clamps.

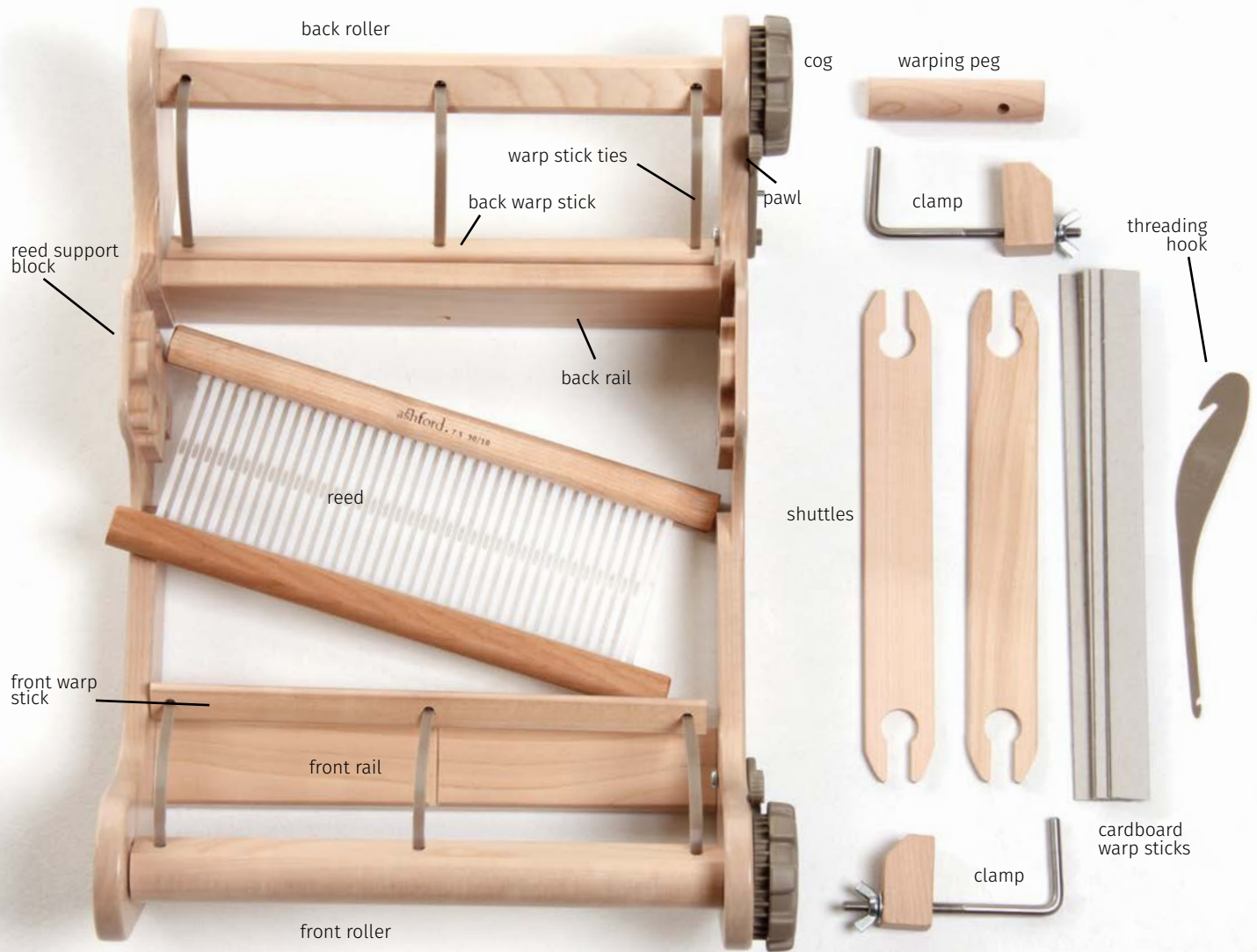

THE LOOM

The reed has holes and slots that the warp threads pass through to create the weaving shed. The reed is also used as a beater to push the rows of weaving into place. The reed included with this loom sets the warp threads at 30 threads to each 10cm section of reed or 7.5 threads to 1 inch. **The shuttle** is used to carry the weft yarn from side to side to make the fabric. The warping peg, a threading hook and 2 clamps are used to thread the warp onto the loom.



25cm (10in)
Loom stand



40cm (16in)
Loom stand

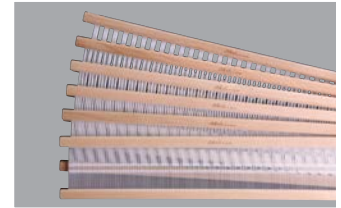

Reeds

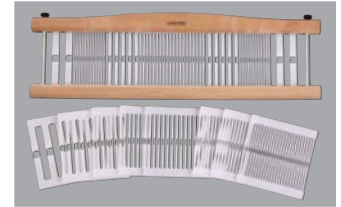

Vari dent reeds



Pick up sticks

OPTIONAL ACCESSORIES

Reeds - 2.5, 5, 7.5, 10, 12.5 and 15dpi (10, 20, 30, 40, 50 and 60/10cm), **Vari Dent Reeds**, **Stick shuttles** - 15cm (6ins), 26cm (10ins), **Pick up sticks**, **Loom stands**.

Welcome to the wonderful world of weaving ...

With the Samplelt Loom you can weave samples, scarves, table runners, place mats, wall hangings or fabric strips to sew together. It is quick and easy to create your own fun and fabulous scarf. Using a plain yarn just follow the warping instructions from step 1 - 26 and then wind a novelty yarn onto the shuttle and weave plain weave as per instructions 27 - 34 for the length of your scarf. Follow steps 66 - 68 for finishing your scarf.

To weave a beautiful sampler using seven decorative weaving techniques follow instructions steps 1 - 69.

To weave your first double heddle project follow the warping and weaving instructions steps 70 - 78.

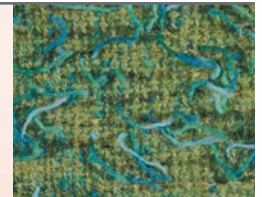



WEAVE A SAMPLER

You will need:

Scissors

A measuring tape

Cardboard warp sticks

A table

A darning needle and a knitting needle

Yarn

For this project we have used Ashford Tekapo Stonewash, a smooth 8ply DK (double knit) sports weight yarn (100% wool; 200m/218yds; 100gms net) with a slightly textured handspun look, for the warp and weft. Assorted novelty yarns are also used throughout the weft.

Quantity

Ashford Tekapo DK yarn – 100gm ball

Novelty yarn – 50gms of one or a variety of yarns

Warp

Ashford Tekapo

Length – 1.40m (56ins)

This length allows 23cm (9ins) at each end for fringe

Number of ends – 74

Finished width – 23cm (9ins)

Weft

Ashford Tekapo and fancy yarns

SHED

The shed is the opening formed in the warp to allow the shuttle to pass.

WARP AND WEFT

These are 2 terms you will need to know as they form the basis of all weaving. The **warp** threads are put onto the loom first. They are held on the loom under tension between the front and back roller. The **weft** threads pass over and under the warp threads to form the woven fabric.

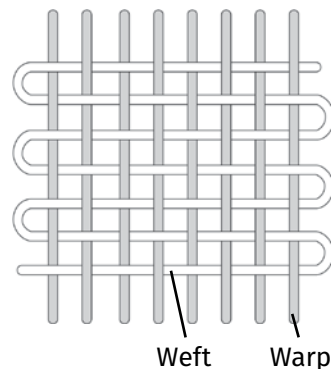



Use a long table or set two tables in place until the warping peg is approx. 2m (78ins) from the back warp stick on the loom.



Insert a clamp into the hole in the back rail and clamp it to the table.



Clamp the warping peg to the other end of the table.

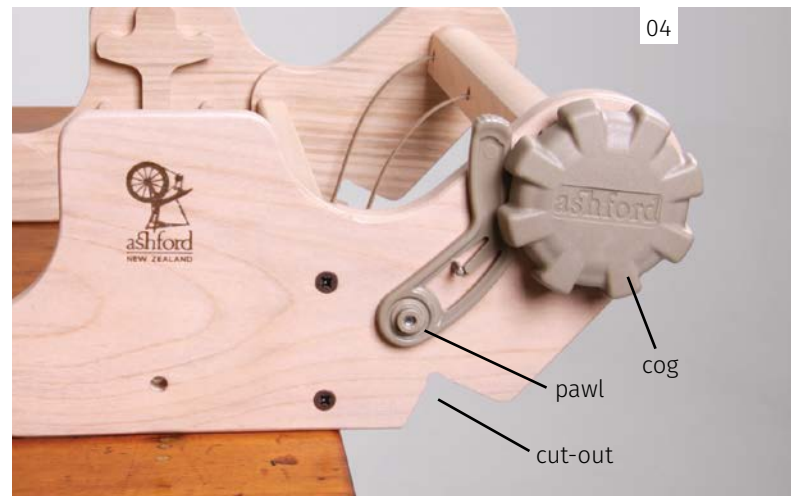

Note: The back of the loom has the cut-out in the lower edge. Engage the front and back pawls into the teeth in the cogs.

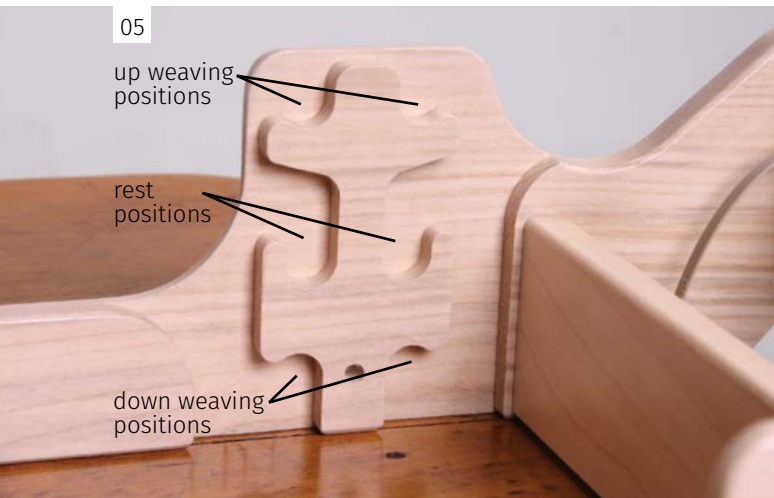

The reed support block can accommodate two reeds. This project only uses one reed.



Place the reed in the rest position.



Tie the warp yarn to the **back** warp stick. The **back** warp stick should be approximately 6cm (2½ins) from the **back** roller.



Push the threading hook through the first slot. Catch the yarn with the hook and pull a loop through the slot.



Take the yarn to the warping peg and loop it over. Sit the ball of yarn on the floor behind the loom.
Hint: Sit the ball of yarn in a bowl so it doesn't roll around on the floor.

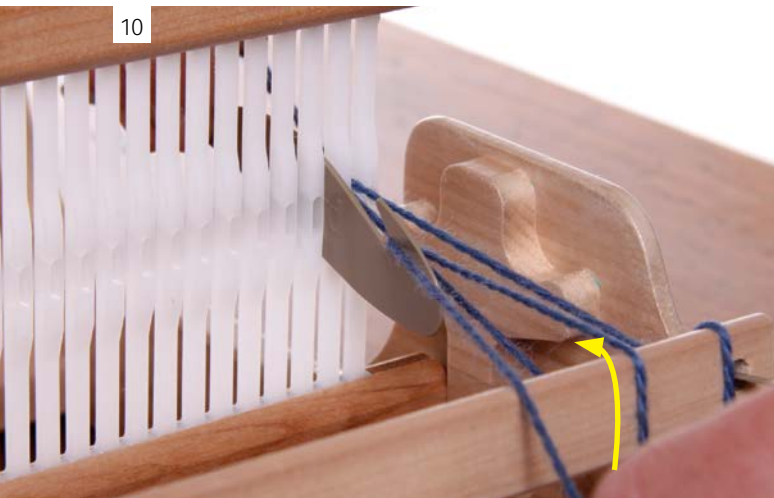

10

Push the threading hook through the next slot. Take the yarn OVER the back warp stick, catch the yarn on the hook and pull a loop through the slot. Place this loop over the warping peg in the same way as the first loop. Try and keep the tension even across the loom.

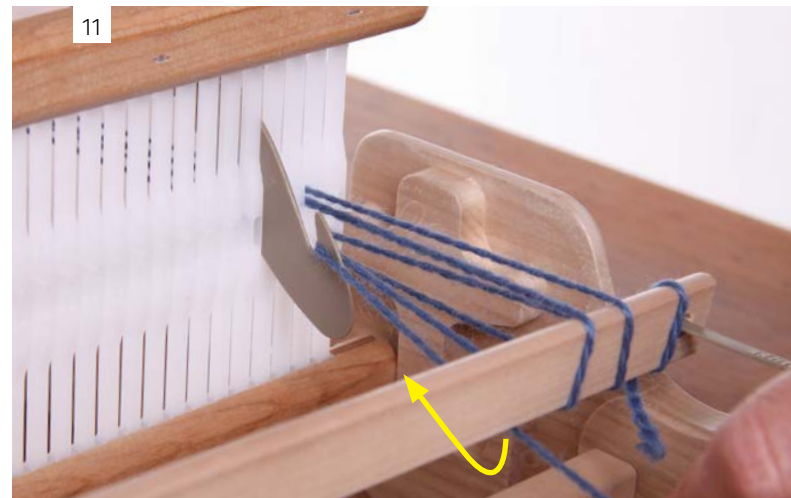

11

Go to the next slot. Take the yarn UNDER the back stick, through the slot and over the warping peg. Continue this way, one yarn thread over, one thread under until you have yarns in every slot.



12

To change colours tie off one colour onto the back warp stick. Tie on the new colour to the back warp stick. Check tension. Cut the last thread at the back of the loom and tie it to the back warp stick.



13

Take a piece of scrap yarn. Tie this yarn firmly around all the warp threads in the front of the warping peg with a bow or knot you can undo easily later.



14

Cut through all the yarn loops at the warping peg.



15

Ask a friend to hold the warp ends for you. They must hold the threads under tension at the tie and move forward as you wind the warp on the loom.

Note: If you are by yourself, refer to the Solo Warping Instructions on our website.



16

Stand at the back of the loom. Turn the back handle towards you until the back warp stick goes around the roller once.



17

Insert a cardboard warp stick or piece of paper the full width of the loom. The cardboard warp sticks or paper separate the yarns and keeps the tension even.

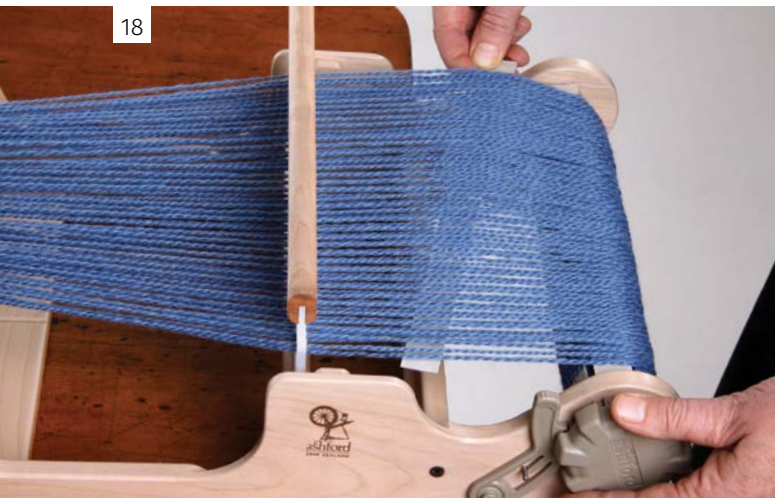

18

Add more cardboard warp sticks or paper as you wind the warp on. Stop winding when the warp tie reaches the front of the loom. Remove the tie. Do not wind any further! Unclamp the loom.



19

BE CAREFUL. DON'T PULL TOO HARD AND BREAK THE THREAD!

Lift the first 2 threads on the left to the top of the slot. Look behind the reed and gently pull one thread out of the slot. The other thread stays in the slot. Use the threading hook to pull this thread through the eye to the left of the slot. Continue across all slots. Now threads are in both eyes and slots.



20

Divide the threads into small groups. Take a group of threads over and around the front warp stick. Divide it in two. Tie around the top of the group in a flat SINGLE knot. Tie the width of the warp in the same way.

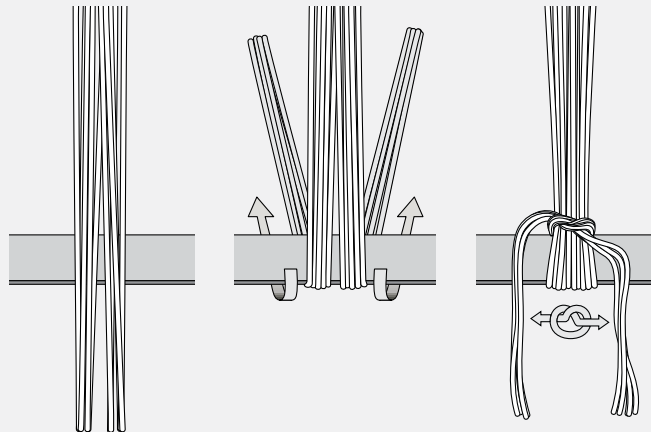

FOR AN ALTERNATIVE TIE-ON METHOD see our YouTube tutorial "Tying a warp on a Rigid Heddle Loom"
<https://youtu.be/bnrCoiJfZVY>



Check the tension. Adjust the knots until all groups are the same tension. **Note:** To adjust a knot simply hold the threads on both sides of the knot and gently pull upwards towards the reed, then retighten.

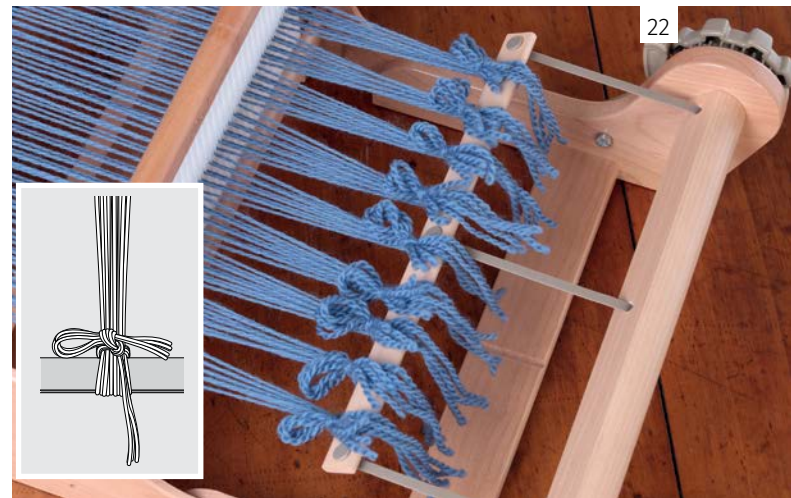

Tie the second half of the knots using a half bow tie to secure. You want to be able to undo these knots easily when your weaving is finished.

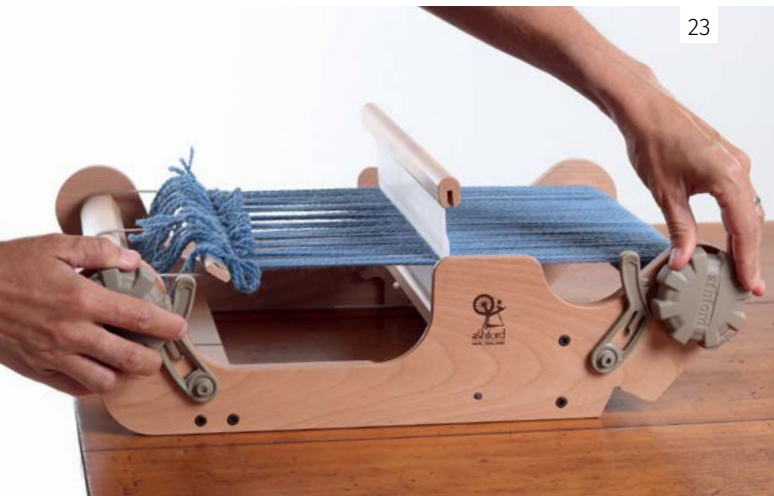

To advance the warp to the front roller, release the tension on the warp by turning the back handle away slightly and pull the pawl out of the cog. Keeping tension on the back handle, wind the front handle towards you until the front warp stick reaches the front roller. Click the back pawl down and retension the warp.



Before weaving, you need to close the spaces the knots have created, this is called spreading the warp. Watch on YouTube <https://youtu.be/A-SW47MtrsQ>. Place the reed in the up weaving position. Insert a loop of scrap yarn, from the right side of the warp, into the shed. DO NOT beat!



25

Change the reed to the down weaving position. Insert a second loop into the shed (ensure the end of the scrap yarn remains on the right side of the warp to allow easy removal). Repeat again in the up position.



26

Use the reed to gently push the scrap yarn towards the knots, until the scrap yarn is compressed. The warp threads will now be evenly spread.



27

Now you are ready to weave. Wind the weft yarn onto the shuttle. Put the reed into the down weaving position. Pass the shuttle through the shed. Use the reed to gently push the first row of weaving down to the scrap yarn.

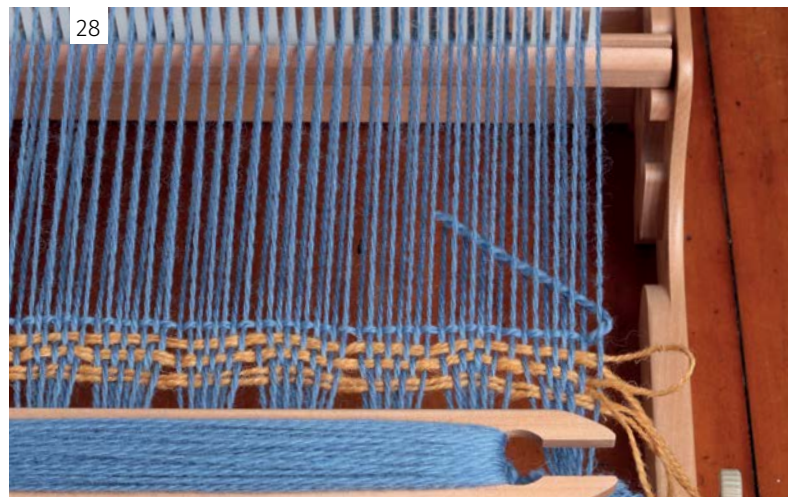

28

Put the reed into the up weaving position. Use your fingers to place the end thread into the shed. Pass the shuttle through the up shed. Use the reed to gently push the second row into place.



29

BEAT GENTLY! THERE MUST BE A SMALL SPACE BETWEEN THE ROWS.

Pinch

30° angle

Hint: To avoid drawing in the sides of your weaving, allow enough weft yarn on each row by passing the shuttle through the shed, pinch the weft thread in line with the outside warp thread and lay the weft in the shed at a 30° angle. Gently push the weft into place with the reed. **Note:** BEAT GENTLY! THERE MUST BE A SMALL SPACE BETWEEN THE ROWS.

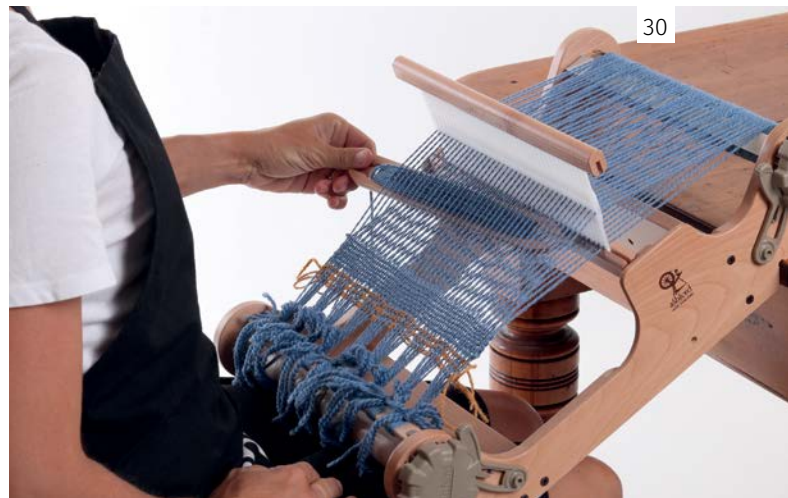

30

Pattern 1: Plain weave

Pass the shuttle through the down shed. Use the reed to gently push the second row into place. Continue plain weave for 8 more rows. Sit in a comfortable chair with the loom in your lap and the back of the loom on the edge of the table.



31

When your work is approx 6cm (2½ins) from the reed, remove the scrap yarn from the warp by gently pulling the last scrap yarn thread.



32

Now it's time to wind the weaving onto the front roller. PLACE THE REED INTO THE REST POSITION. Release the tension on the warp by turning the back handle away slightly and pull the pawl out of the cog. Turn the handle towards the front of the loom so some of the warp unwinds, replace the pawl into the cog to stop it advancing too much. Now wind the front handle towards you until your work is approx. 5cm (2ins) from the roller. Check your tension. As you weave continue winding your work onto the front roller in this way.



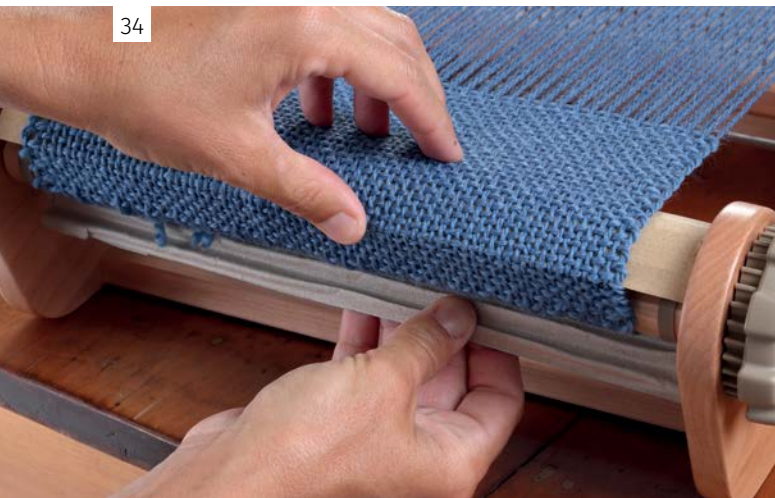

34

Hint: Add a piece of cardboard to cover the knots as you wind your weaving onto the front roller.



35

Pattern 2: Rya knots

Cut 12cm (4¾ins) pieces of novelty yarn and put into groups of two or three pieces.



36

Place the reed in the rest position. Knot the novelty yarn groups into the weft as per the diagram.

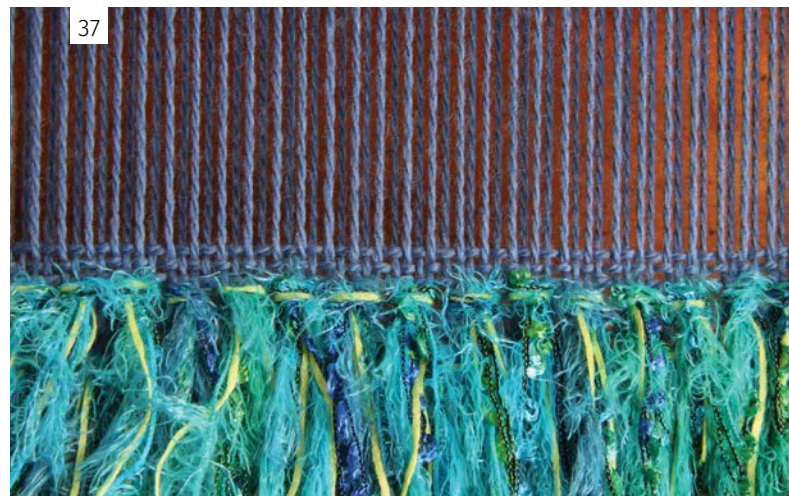

37

Continue across the row. Weave 3 rows plain weave in Tekapo yarn after the row of knots. Repeat pattern 2, two more times.

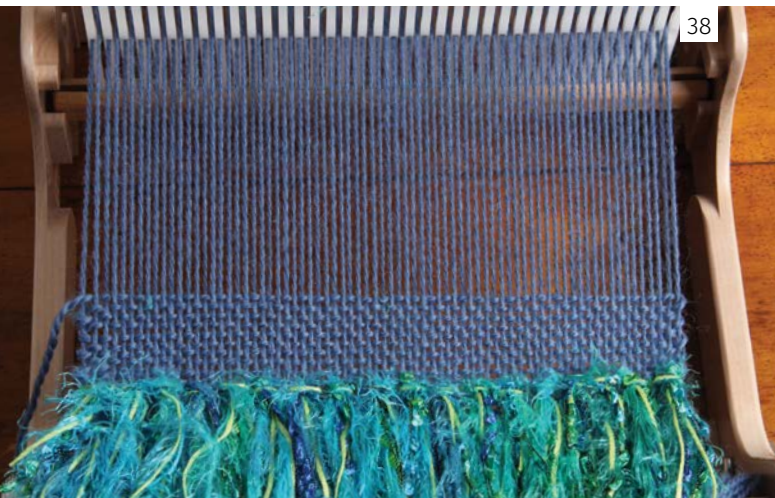

Trim the knot ends to the desired length. Weave 10 rows plain weave.

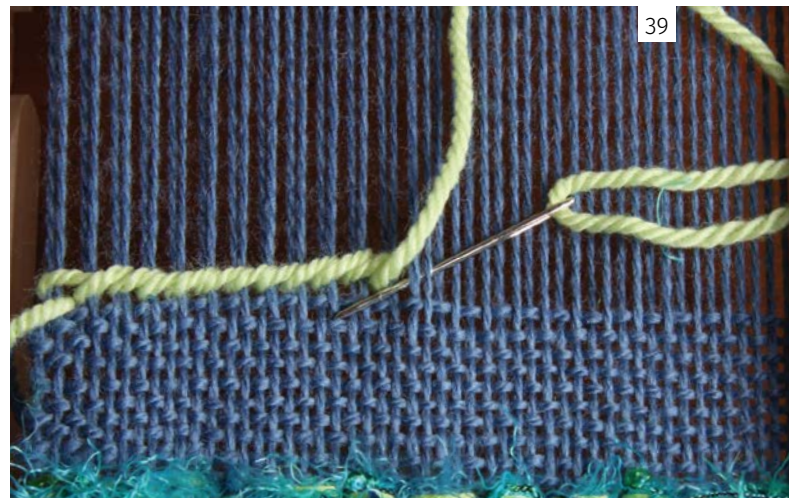

Pattern 3: Soumak

Place the reed in the rest position. Start on the left: using a darning needle, take the yarn over 4 warp threads (to the right) and back under 2 threads (to the left). Repeat across row.

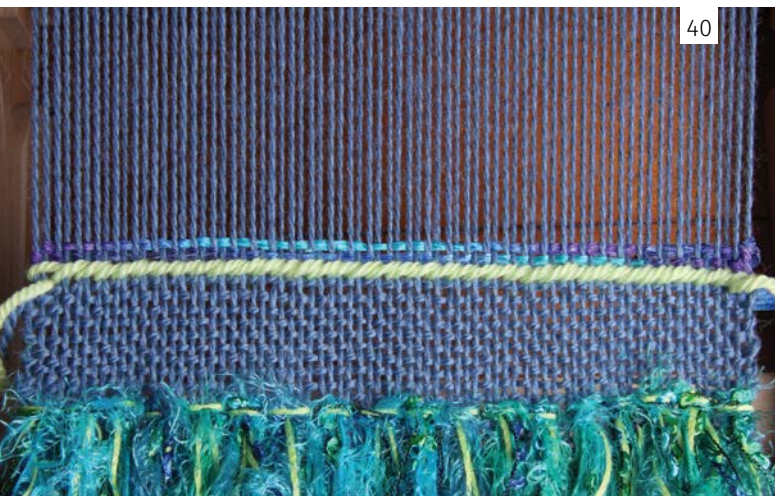

Weave 2 rows of plain weave in novelty yarn.

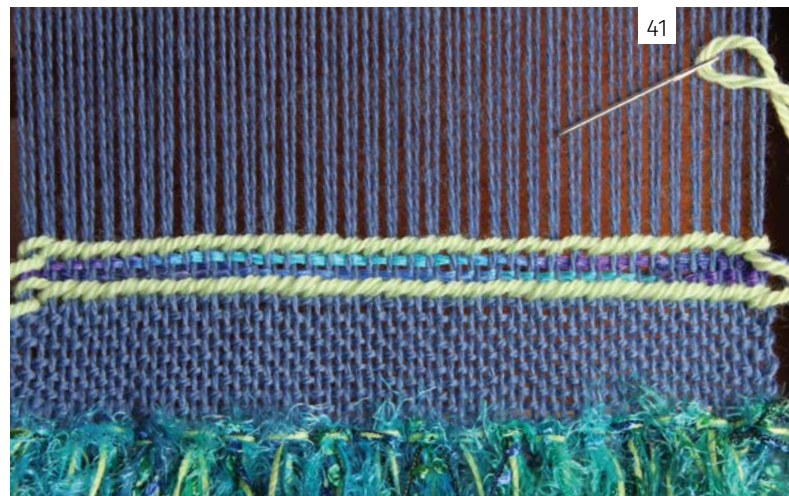

Repeat step 39. Weave 10 rows plain weave.



42

Pattern 4: Textured Weave

There are four rows to the pattern. Place the reed in the down position, with the pick up stick (spare shuttle) pick up every second thread behind the reed. Under 1, over 1 across the width.



43

Row 1: With the reed in the down position. Place the pick up stick on its edge behind the reed to create the shed. Weave one row.



44

Row 2: Plain weave. Slide the pick up stick to the back of the loom. Place the reed into the up position. Weave one row.



45

Row 3: Place the reed into the down position. Weave one row.
Row 4: Place the reed into the up position. Weave one row.
The pick up stick stays at the back of the loom.



Repeat pattern 4, four more times.
Weave 10 rows of plain weave.
Keep the pick up stick at the back of the loom as it will be used again in pattern 5.

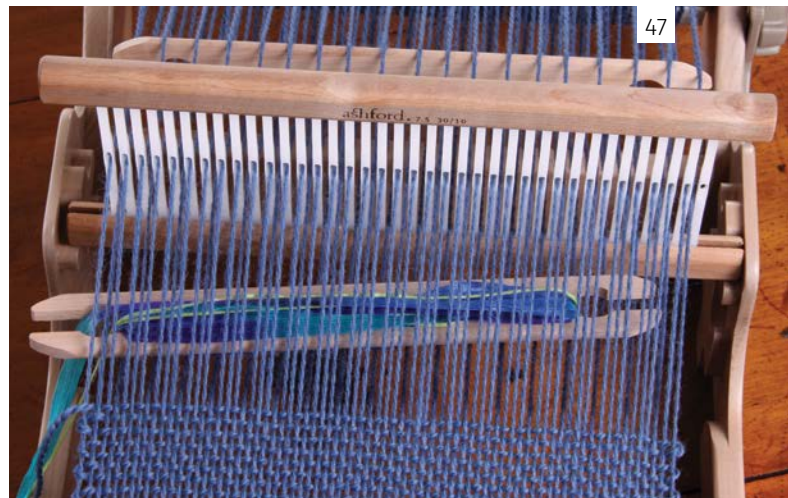

Pattern 5: Window Weave

There are four rows to the pattern. Row 1: Place the reed in the up position. Place the pick up stick on its edge behind the reed to create a new shed. Weave a row with novelty yarn. Push the pick up stick to the back.



Ensure you always catch the end thread for neat edges.

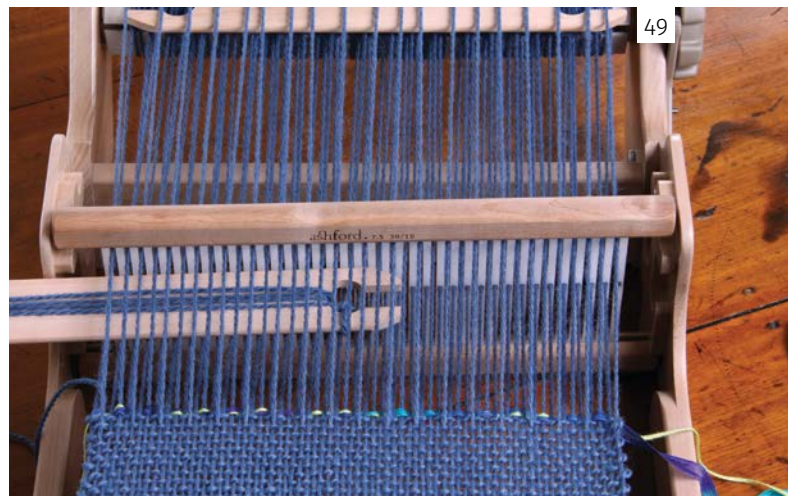

Row 2: Place the reed in the **down** position. Weave one row of plain weave.

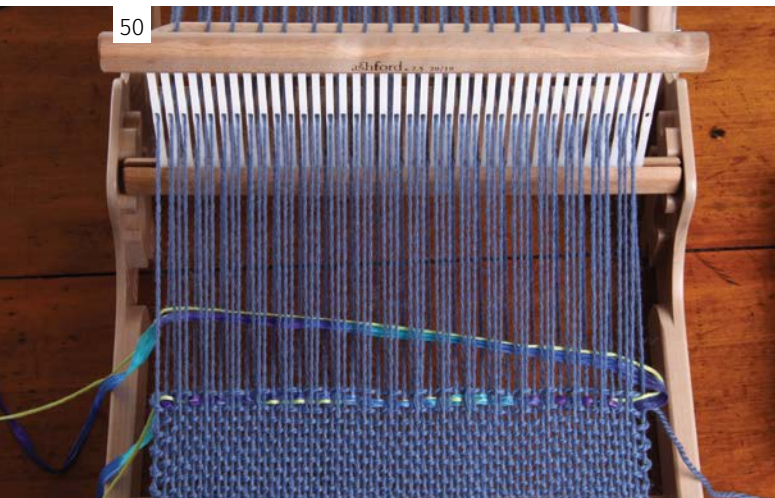

Row 3: Repeat row 1.

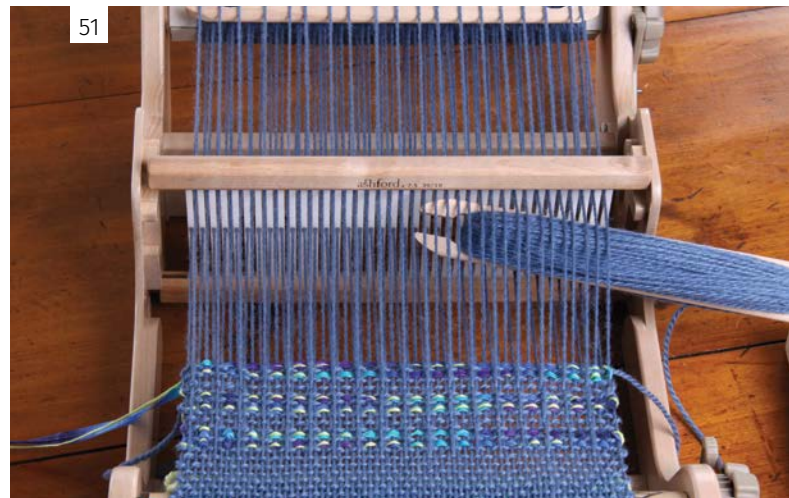

Row 4: Weave 3 rows of plain weave.
Repeat Pattern 5, two more times.
Weave 7 rows of plain weave.

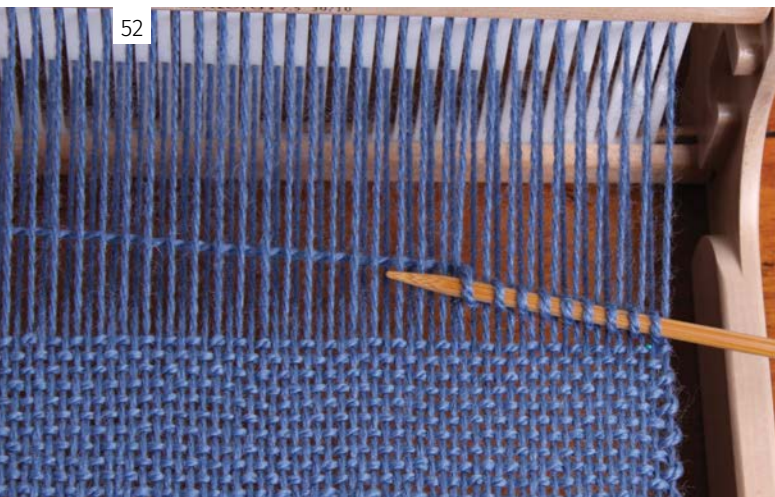

Pattern 6: Pile Loop

Row 1: Place the reed in the **down** position. Take shuttle through shed from right to left. **DO NOT** beat. Starting on the right using a knitting needle, pick up the yarn between every 2 warp threads across the width to form a loop around the needle.

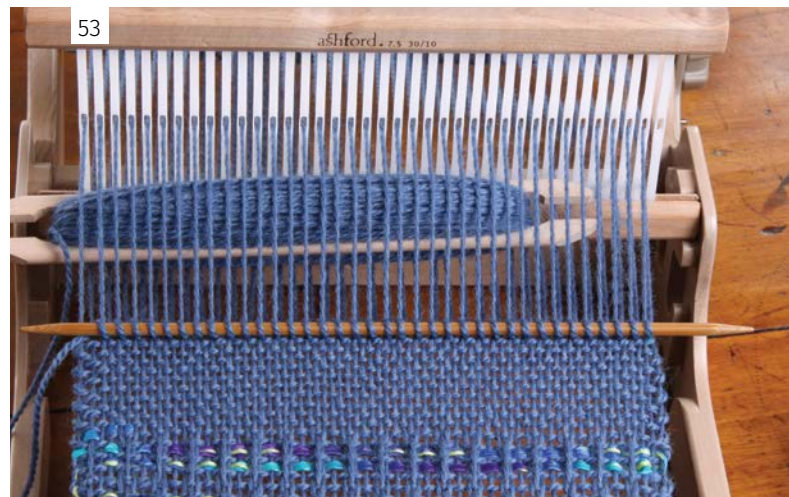

Row 2: Place the reed in the up position and weave a plain row.



54

Carefully pull the needle out. Beat loops firmly into place.
Repeat pattern 6, two more times.
Weave 10 rows of plain weave.

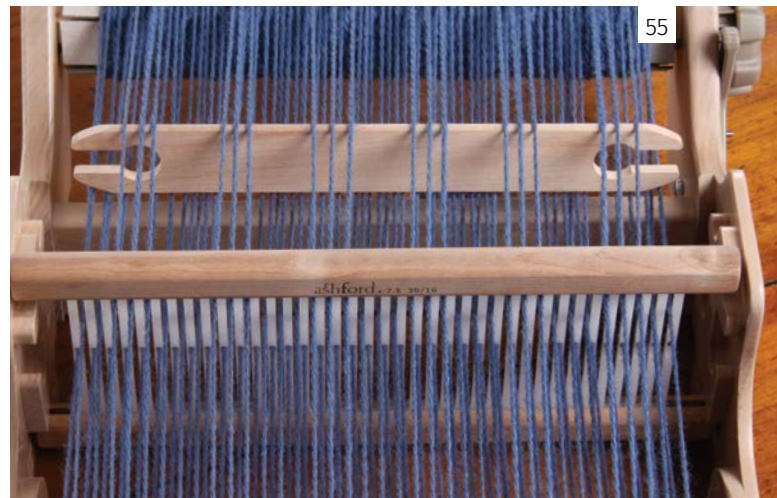

55

Pattern 7: Weft Floats

There are two rows to the pattern. Place reed in the **down** position. With the pick up stick, pick up threads in the following sequence: over 2, under 3, over 3. Continue under 3, over 3 across the width.

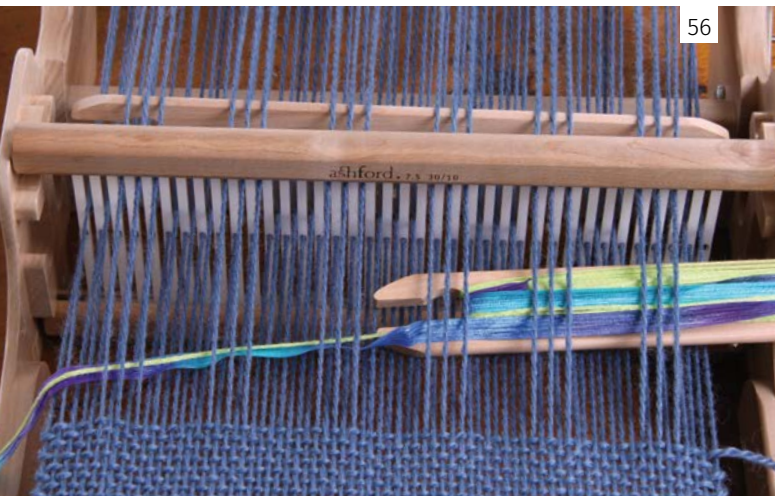

56

Row 1: Place the pick up stick on its edge behind the reed to create the shed. Weave a row with novelty yarn. Push the pick up stick to the back.



57

Row 2: Place the reed in the **up** position. Weave a row of plain weave. Remember to go around the novelty yarn thread and catching the edge thread.

Note: Ensure you always catch the end thread for neat edges.

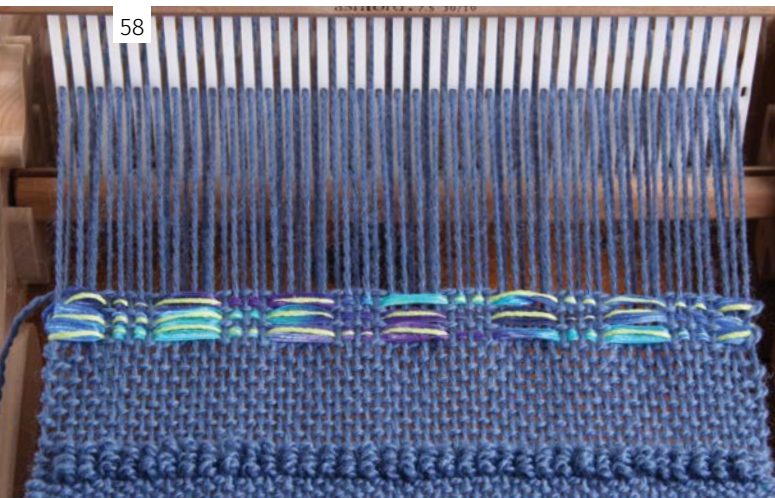

58

Repeat these 2 rows two more times.
Weave 20 rows of plain weave.



59

Pattern 8: Brooks Bouquet

Place reed in the **down** position. Weave through the shed and bring your shuttle out after the 6th thread. Gently beat. This is the outside border.



60

Place the reed in the **rest** position. Pass the shuttle under the next 5 threads, and then take the shuttle back around and under the last 4 threads. Pull the yarn to form a "bunch".

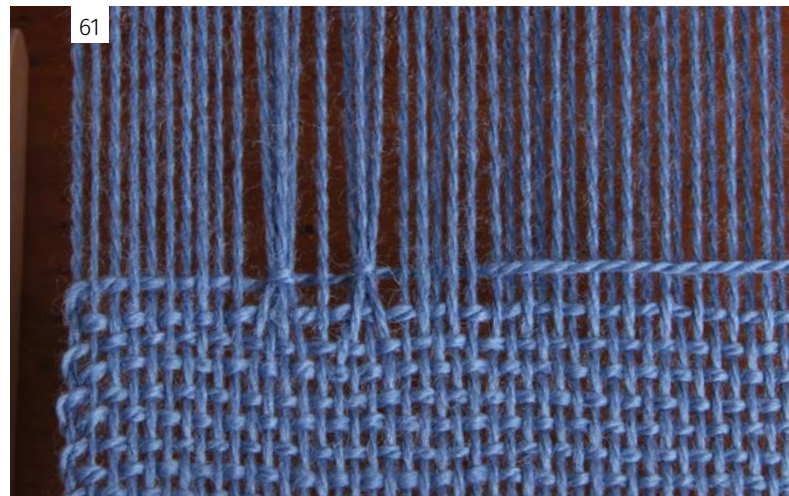

61

Continue across the row, stopping when there are 10 threads on the right - this will be your outside border.

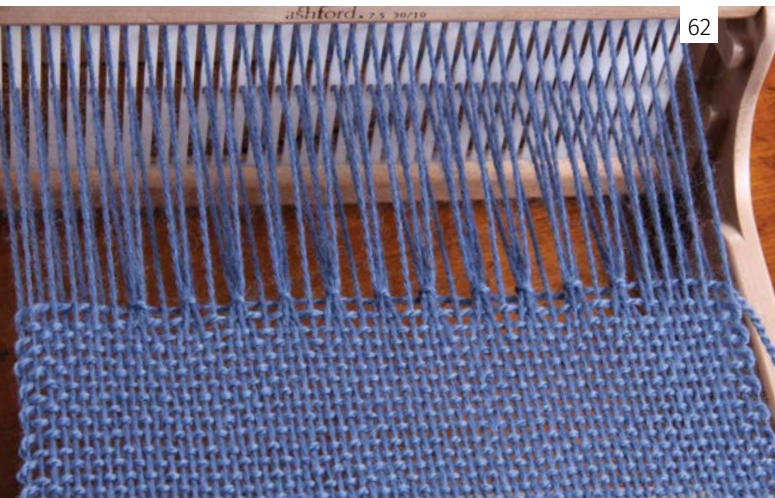

Place the reed back into the **down** position and weave under the last 5 threads. Gently beat.

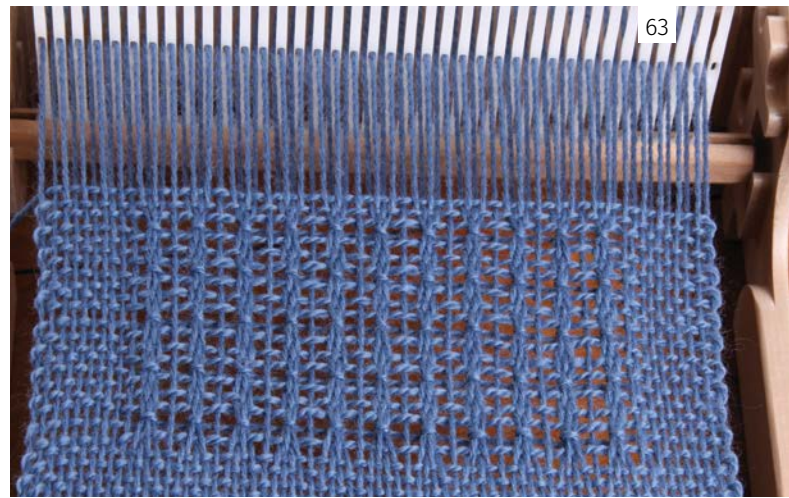

Weave 3 rows in plain weave. Repeat 4 more times (5 sets in total).
Weave 20 rows in plain weave.



You have now woven half of the Sampler. Reverse the weaving sequence starting at pattern 7 then pattern 6 etc. Weave the Soumak technique reverse (right to left).

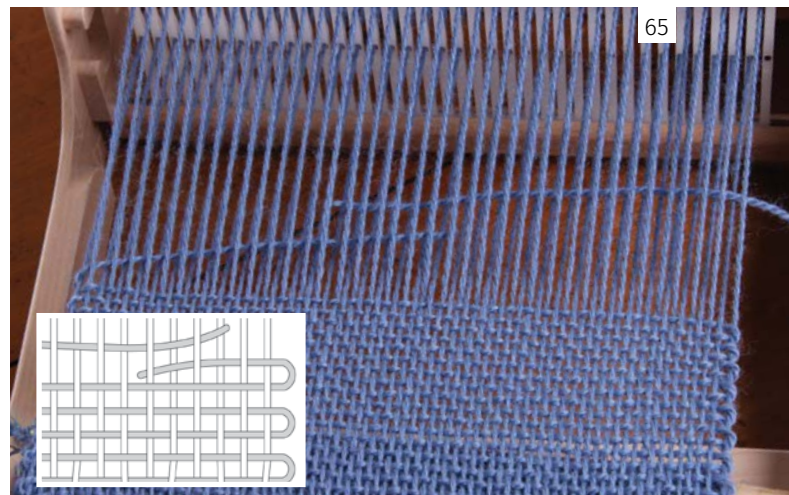

Joining in a new thread: At some stage the yarn on the shuttle will be finished. Wind some more yarn on the shuttle. Overlap the new yarn across the old yarn into the same shed. Beat both yarns together.

66



When you reach the end leave enough warp for your fringe. Cut the weft yarn and leave the end out. Cut the warp yarns along the back warp stick. Take care not to cut the warp stick ties.

67



Release the front pawl and unwind the weaving from the front roller. Undo the knots on the front warp stick and remove the work from the loom.

68

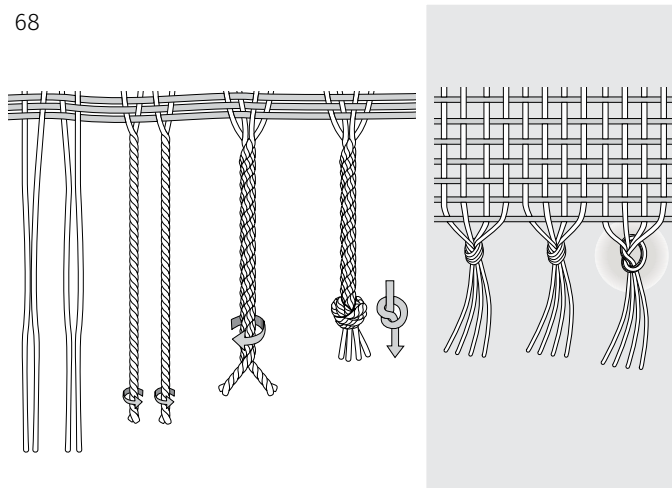

Lay your work on the table and tie the ends in groups of four. Use overhand knots or twist with the Ashford Fringe Twister. Darn the end of the weft thread into your work using a wool needle.

69

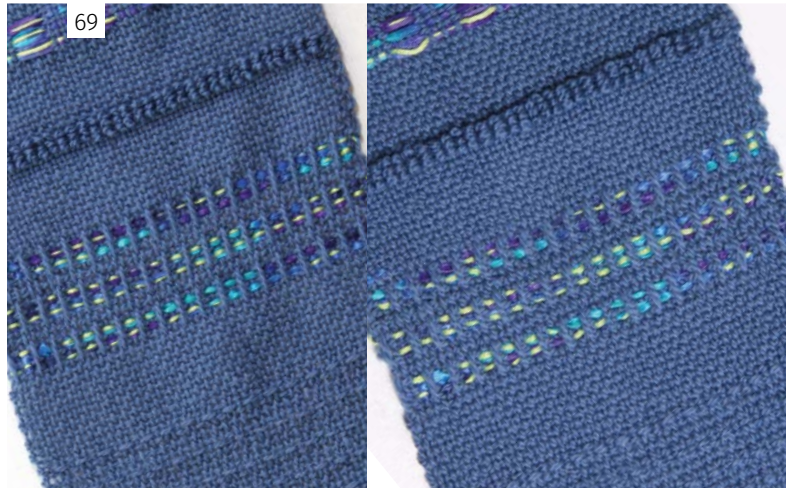

Straight off the loom

Washed

See washing instructions on the next page.

FINISHING

The woven work should be washed so the threads open up and fill the spaces to give the fabric a 'finished' look.

WASHING

Wash the weaving gently in warm water with a little detergent. Push up and down for a minute. Let the soapy water drain away and rinse the scarf in warm, clean water. Lay flat to dry. While the work is still damp, cover it with a soft cotton cloth and press with a warm iron.

HELPFUL HINTS

Tying Knots

When you tie any knot during weaving you will need to undo it again at some stage. Always tie a knot that you can undo easily.

Beating

Always beat gently. Sometimes the work will look a little open. Remember, the work is under tension on the loom and will come together when taken off. Also, the washing process will close the gaps a little.

RESOURCES

The Ashford Book of Rigid Heddle Weaving

By Rowena Hart

All you ever needed to know about rigid heddle weaving. Easy warping, weaving techniques and projects including brooks bouquet, bronson lace and weaving with the second heddle kit.

Create beautiful garments and homeware.
123 pages

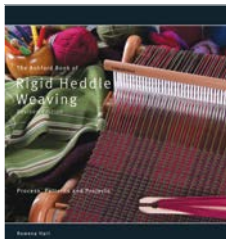

Youtube tutorials



Waxing a Samplett Loom



Assembling a Samplett Loom



Weaving on the Samplett Loom



Simple warping on the Rigid Heddle Loom



Tying a warp on a Rigid Heddle Loom



Spreading a warp on a Rigid Heddle Loom



Using the Fringe twister



Peruvian Diamonds

www.youtube.com/user/AshfordHandicrafts/videos



70

Place one reed in the back rest position. Warp across the reed in the normal way but place two loops in each slot, one loop of black and one of white (4 threads in each slot). Follow steps 12 - 19 to finish the warping sequence.



71

With the front of the loom facing you and starting from the left use a threading hook to take one of the black ends from the slot and thread it through the eye to the right. Continue across the reed.



72

Place the second reed in the front rest position. Drape all ends from the back reed over the front reed (this will help to make the threading easier). Starting on the left, take the first group of 4 ends (2 white ends and 1 black end from the slot and 1 end from the eye to the right and thread all 4 ends through the slot directly in front in the front reed.



73

Continue across the reed. Now you will have 4 ends (2 black and 2 white) in each slot in the front reed.

74



Take the first group of 4 ends and pull the black pair down and the white pair up. Take 1 white end from the pair of white ends and thread through the eye to the left.

75

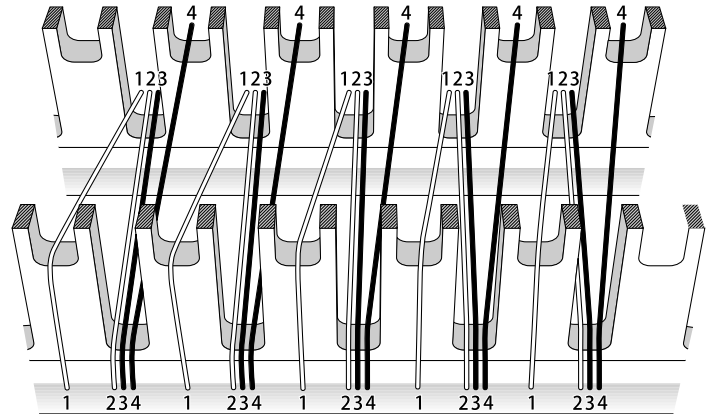

Continue across the reed. **Note: Check there are no crosses between the reeds.** If the ends are crossed remove and repeat step 74. Your threading will look like this diagram.

Tie to the front warp stick following steps 20 - 26.

PLAIN WEAVE



Plain weave - One layer double the ends per cm/in
Place both reeds in up position, weave one row.
Place both reeds in the down position, weave one row.
Repeat step 1.

Note: When changing the shed leave the front reed hanging.

CREATING ADDITIONAL SHEDS



PICK UP STICK A



PICK UP STICK B

Pick Up Stick A - Place both reeds in down position. Behind the back reed lift up all the white threads on the top and insert a pick up stick (A). Slide stick A to the back beam.
Pick Up Stick B - Place both reeds in the up position. Slide pick up stick A forward and insert pick up stick B into the bottom shed that is formed. Slide both sticks to the back beam.

TWO LAYERED WEAVING

It is easy to create two separate layers of cloth at the same time. *Hint:* When weaving two separate layers do not go around the alternate weft thread.

Top Layer - White warp and weft.

Shed 1 - Both reeds in the rest position, slide pick up stick A forward and turn on side.

Weave one row of white. Slide pick up stick A to the back.

Shed 2 - Place the front reed in the up position. Weave one row of white.

Bottom layer - Black warp and weft.

Shed 3 - Both reeds in the rest position, slide pick up stick B forward and turn on side.

Weave one row of black. Slide pick up stick B to the back.

Shed 4 - Place the back reed in the down position. Weave one row of black.

Repeat weaving one top layer and then one bottom layer until weaving reaches the desired length. To join the layers at anytime place the back reed up and weave one row of either black or white.



BROOKS BOUQUET

The beautiful lace of Brooks Bouquet is enhanced by the black second layer backing cloth.

1. Weave 4 rows on the bottom black layer and 4 rows top white layer (see instructions above).
2. Weave 4 more rows on the bottom black layer.
3. Place both reeds in the rest position and slide pick up stick A forward and turn on side.
4. Slide the shuttle with the white yarn under the first 6 ends and back over and around the last 4 ends and pull the yarn to make a "bunch".
5. Pick up the next 4 ends with the shuttle and take it back over and around these 4 ends and under the next 4 (you will be going under 8 ends).
6. Continue across row (check that the number of ends will make equal-sized bunches).
7. When there are 6 ends left use the shuttle to pick up 4 ends and take the shuttle around the 4 and under the 2 ends to finish the row.

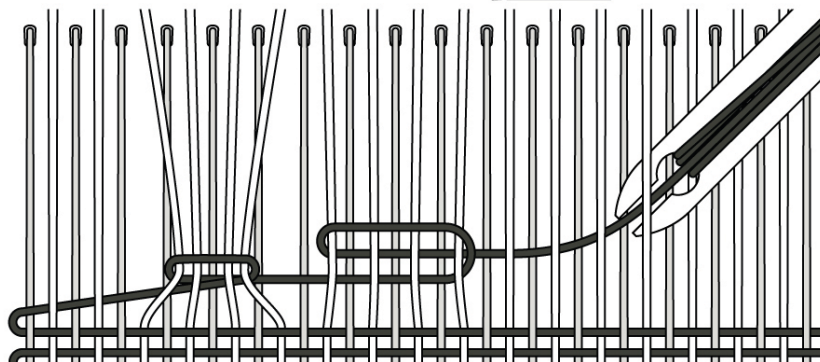
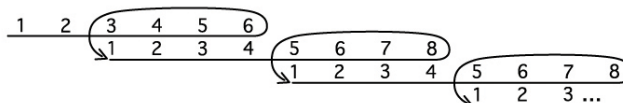

8. Weave 4 more rows bottom and top layers.
9. Join the two layers (see above).
10. Repeat instructions 1-9 for desired result.

Hint: Use your fingers to adjust the "bouquets" so they are level. Secure top end with hemstitch or machine zigzag stitch. Do a twisted fringe at the beginning of the weaving, which will become the bottom of the hanging. Handwash in warm water. Lay flat to dry. Fold top over 3cm (1 1/2 ins) stitch down to make pocket to insert hanging needle.



For more information, helpful hints and inspiration we recommend The Ashford Book of Rigid Heddle Weaving. Visit our website to view our tutorial videos www.ashford.co.nz

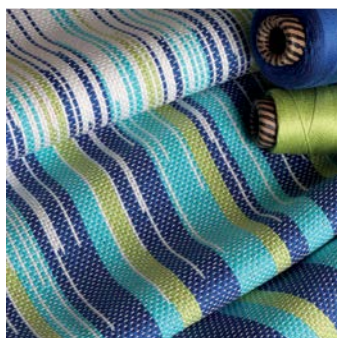

LTWSL VW2

Ashford Handicrafts Limited
415 West Street, PO Box 474, Ashburton, New Zealand
Ph +64 3 308 9087 sales@ashford.co.nz www.ashford.co.nz

ashford
WHEELS & LOOMS